

Fastener Tools

Apex®



COOPER PowerTools

Table of Contents

Introduction	iv	1/2" Drive Sockets, Extensions, Adapters & Universal Wrenches	
Bits		SAE Sockets & Universal Wrenches48
Phillips	1	Metric Sockets & Universal Wrenches54
Slotted	6	Spline & Torx® Sockets58
Torx®	10	Extensions & Adapters58
Torx Plus®	12	5/8" Drive Sockets, Extensions, Adapters & Universal Wrenches	
Pozidriv®	13	SAE Sockets & Universal Wrenches60
Sel-O-Fit®	14	Metric Sockets61
Frearson	15	Extensions & Adapters61
B.N.A.E.	15	3/4" Drive Sockets, Extensions, Adapters & Universal Wrenches	
Socket Head	16	SAE Sockets & Universal Wrenches62
Square Recess	18	Metric Sockets64
Pipe Plug Inserts	20	Extensions & Adapters64
Torq-Set®	21	1" Drive Sockets, Extensions & Adapters	
Tri-Wing®	22	SAE Sockets & Budd Wheel Sockets65
Hi-Torque®	23	Metric Sockets66
Triple Square	23	Extensions & Adapters66
Bit Holders		1 1/2" Drive SAE Sockets & Adapters67
Hex Drive	25	2 1/2" Drive SAE Sockets & Adapters67
Female Square Drive	26	Anti-Mar Protective Covers	
Hand Drivers		µ-Guard68
Replaceable Bit	28	Free-Spin72
Awls	28	Engineered Solutions76
Hex Drive Nutsetters, Extensions & Universal Wrenches		Special Sockets, Adapters & Accessories	
Nutsetters	27	Reversible Sockets82
Extensions	29	Tap Holding Sockets82
Universal Wrenches	31	Grease Fitting Sockets83
1/4" Drive Sockets, Extensions, Adapters & Universal Wrenches		Drill Holders83
SAE Sockets and Universal Wrenches . . .	35	Extensions & Adapters, Universal
Metric Sockets and Universal Wrenches	37	Wrenches & Budd Wheel Sockets83
Spline and Torx® Sockets	38	Socket Retaining Rings84
Extensions and Adapters	39	Adapters84
3/8" Drive Sockets, Extensions, Adapters & Universal Wrenches		Quotation Worksheets86
SAE Sockets & Universal Wrenches	40	Part Number Index89
Metric Sockets & Universal Wrenches . .	44		
Spline & Torx® Sockets	47		
Extensions & Adapters	47		

Quick Reference



Bits

1 – 24



Bit Holders

25 – 26



Hand Drivers

28



Hex Drive Nutsetters, Extensions & Universal Wrenches

27 – 31



1/4" Sockets, Extensions, Adapters & Universal Wrenches

35 – 39



3/8" Sockets, Extensions, Adapters & Universal Wrenches

40 – 48



1/2" Sockets, Extensions, Adapters & Universal Wrenches

49 – 59



5/8"-2 1/2" Sockets, Extensions, Adapters & Universal Wrenches

60 – 67



Anti-Mar Protective Covers

68– 80



Special Sockets, Adapters & Accessories

81 – 85

Part Number Index

89 – 95

The Apex heritage of quality, delivery and support



For more than half a century Apex has maintained a position of leadership in industrial fastening tools. Today, Apex stands ready to improve the productivity of assembly operations around the world with unsurpassed tool performance and customer service.

Precision Fit

Apex quality begins with select raw materials. Only carefully chosen, high grade tool steel is used. Each tool is manufactured to the tightest tolerances in the industry...most are even tighter than licensing agreement requirements. Our bits meet the most stringent government and military specifications where applicable (ie. MIL-B-9946/5 for HTS Hi-Torque® bits used in aerospace assembly).



Precision fit of Apex tools eliminates "cam-out" and premature bit failure.

Apex sockets, nutsetters and universal wrenches have hex tolerances that are on average 48% tighter than DIN and 35% tighter than ANSI requirements. With Apex you are assured of an exact, sure fit.

Apex sockets, nutsetters and universal wrenches have hex tolerances that are on average 48% tighter than DIN and 35% tighter than ANSI requirements. With Apex you are assured of an exact, sure fit.



Precision-manufactured Apex tools are virtually wobble-free.

All Apex sockets and extensions have the tightest tolerances for straightness and concentricity in the industry. Tools that run true perform better and last longer.

Lasting Performance

Each Apex tool is tempered with our proprietary heat treating process that lets you select the degree of hardness your particular application requires. Choose from tough, non-brittle durability that stands up to torque, to the hardest heat treat available in the industry for the ultimate in wear resistance.



Apex bits & sockets last ten times longer than most of our competitors.

Apex offers a choice of three heat treat hardness levels in many of our screwdriver bits to match the application. These heat treats are specified by a letter suffix as follows:

- X - Hardest heat treat in the industry**
- I - Intermediate hardness**
- R - Lowest hardness**

Our experienced staff can help in selecting the best heat treat for your particular application.

Innovative Solutions

Throughout our history Apex has partnered with the leading fastener manufacturers to assist in the development of new fastening technologies. Today, many of these new tools that are now common can trace their history back to Apex engineering.

Recently Apex introduced a family of protective covers to satisfy the growing demand for products that prevent in-system damage. The family includes **μGuard™**, **FreeSpin™** and **Engineered Products**.



Unsurpassed Offering



This catalog contains 3,000+ of the most frequently requested bits, sockets and fastening accessories. Our entire active offering approaches 10,000 sellable part numbers. If the tool you need does not appear in this catalog, give us a call. The

odds are, we may have what you need as a non-catalog item. If not, our experienced staff of tooling experts can design and manufacture "specials" to meet the needs of your specific applications. You can even submit special requests on-line at our website www.apex-tools.com by completing the simple forms.

This flexibility has helped make Apex the only manufacturer which is a market and technology leader in all of the following industrial product categories: Bits & Bit Holders, Impact Sockets, Extensions and Universal Wrenches.

Availability & Service

Apex has approximately 2,000 authorized distributor locations globally to provide product off-the-shelf as well as knowledgeable service and support. Apex stocks over 1,000 part numbers and a multitude of blanks to manufacture several thousand more in order to support our strong global distribution network.



COOPER PowerTools



Important Notes

User safety tips

- Always wear safety glasses when using any tool.
- Always visually inspect tool for damage and cracking. Immediately replace all damaged tools.
- Do not modify or alter any tool.
- Do not use tools beyond their limit or useful life.
- Contact Apex for the recommended operating torque of any tool.

Selecting the proper heat treat for bits

Choosing the proper heat treat for screwdriver tools is important in achieving long tool life. Different applications, different operators, and different power tools require different heat treats. Apex offers a choice of three heat treat hardness levels in many of our screwdriver bits to match the particular customer's application. These heat treats are specified by a letter suffix as follows:

X - The hardest heat treat in the industry

I - Intermediate hardness

R - Lowest hardness

Selecting the heat treat best suited for a particular application may require some trial and error. The proper heat treat depends on the failure mode. If the bit breaks or shatters, select a bit with less hardness. If the failure mode is wear, select a harder bit. Many times both breakage and wear may occur within the same application. This can be due to a number of factors such as a different operators, different torque values, and different power tool settings.

In general, high torque applications require "R" heat treats to withstand twisting and resist breakage. The "X" heat treat is most suitable for low torque applications, particularly if hardened screws are used.

If a failure occurs, a change in hardness may result in better service. The "X" heat treat is most common and should be selected unless the specifics of an application or an existing problem would suggest using "I" or "R" hardness.

To specify a particular heat treat, add a letter suffix to the part number. For example, to specify "X" hardness in a #2 Phillips insert, the part number would be 440-2X. Not all Apex bits are available in all heat treats. Special heat treats can be supplied for a particular application. Contact your Apex representative for specific recommendations.

Since "X" hardness is the most popular with our customers, it is our default product where "X" designation may be omitted from the part number. For all other hardness designations, the product will be stamped with the appropriate hardness designation letter.

Warning

- Using any adapter may result in a torque overload and failure in the adapter, socket or fastener.
- Do not use thin wall sockets with impact power tools.
- Do not use universal wrenches with impact power tools.

APEX Solutions



What's the difference between an insert and a power bit?

Insert bits are commonly used with a bit holder in power tool applications. This combination is economical, provides flexibility and allows a fastener to be magnetically held by the bit. Power bits are placed directly into the power tool chuck. See pages 25-26 for a complete listing of Apex bit holders.

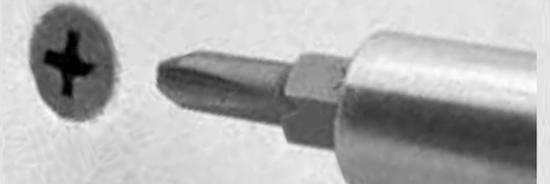

What's the advantage of reduced diameter bits?

Reduced diameter bits are ideal for driving screws below the surface of drywall.

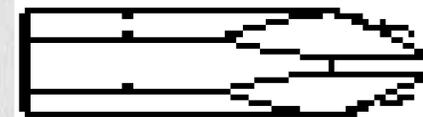

What's the advantage of 27 Series bits?

27 Series bits are ideal for poorly recessed Phillips screws. A wider tip design fills out an inexact recess to make better contact.

What's the advantage of Apex® ACR® bits?

Painted, coated or corroded fasteners can present special problems. Apex® ACR® insert bits' special wing-face ribs grip screw recesses to reduce stripping and cam-out which can result in damage to the surrounding workpiece. Choose from bits ribbed for screw removal, driving or both. They're also available in both insert bits and power drives.

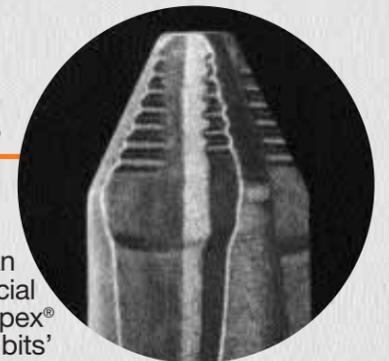

Why do Apex bits last so much longer?

Apex's premium tool alloys and proprietary heat treat help avoid typical problems such as shattering and premature bit wear. Most Apex bits are available in three different heat treat hardnesses. Refer to page vi for information on selecting the proper heat treat.

If the tool you need does not appear in this catalog, give us a call. The odds are, we may have what you need as a non-catalog item. If not, our experienced staff of tooling experts can design and manufacture "specials" to meet the needs of your specific application. Give us a call at 1-800-845-5629 or visit our website www.apex-tools.com.

In this section...

Insert and Power Drive Bits



For all these fastener styles:



Bit Holders, Nutsetters, Extensions and Universal Wrenches

Bit holders adapt hex drive and female square drive power tools to a variety of insert bits. Hex drive nutsetters, extensions and universal wrenches allow nutrunning in all types of applications.

Selecting the correct Phillips point size

Apex bits in these five point sizes will drive ANY Phillips screw

Point Size	Wood Screws			Machine Screws			Sheet Metal Screws Flat, Round, Oval, Stove, Binding
	Body Dia.	Flat, Oval	Round	Flat, Oval, Binding	Round, Fillister	Truss, Brazier, Button	
0	0	0	0	0	0	0	
1	3/16	2	2	2	2	2	2
		3	3	3	3	3	
		4	4	4	4	4	
2	1/4	5	5	5	5	5	5
		6	6	6	8	6	
		7	7	8	8	10	7
		8	8	10	10	8	
		9	9	10			
3		10					
	5/16	10	12	12	12	12	12
		12	14	1/4	1/4	1/4	
		14	16	5/16		14	
4							
		16					
	3/8	18	18	5/16	3/8	5/16	
		20	20	3/8	7/16	3/8	
		24	24	7/16	1/2	7/16	
	1/2	1/2					

IMPORTANT The table above will enable you to determine the Phillips point size required for any Phillips screws or bolts. The No. 2 and No. 3 point sizes cover the range of Phillips screws most commonly used. The Apex Phillips bits on the following pages are available in point sizes to drive any Phillips screw.

1/4" Hex Insert Bits



Part Number	Point Size	Overall Length		
		In.	mm	
440-1X	1	1	25	
440-115X	1	1 1/2	38	
440-12X	1	2	51	
440-125X	1	2 1/2	64	
440-13X	1	3	76	
440-2X	2	1	25	
440-2I	2	1	25	
440-215X	2	1 1/2	38	
440-22X	2	2	51	
440-225X	2	2 1/2	64	
440-23X	2	3	76	
440-24X	2	4	101	
440-255X	2	5 1/2	140	
440-26X	2	6	152	
440-27X*	2	1	25	For shallow screw recesses
440-3X	3	1	25	
440-3I	3	1	25	
440-3125X	3	1 1/4	32	
440-3BNX	3	1 1/4	32	Large body
440-32X	3	2	51	
440-325X	3	2 1/2	64	
440-33X	3	3	76	
440-34X	3	4	101	
440-4X	4	1 5/16	33	

*For shallow screw recesses. See Tool Tip on page 7

1/4" Hex Insert Bits – Limited Clearance



Part Number	Point Size	Overall Length		Turned Length (A)		Turned OD (B)	
		In.	mm	In.	mm	In.	mm
446-0X	0	1	25	7/16	11	0.108	4.06
446-1X	1	1	25	7/16	11	0.108	4.06
446-12X	1	2	51	7/16	11	0.108	4.06
SD-1055-A	1	2	51	1 3/8	35	0.108	4.06
446-2X	2	1	25	7/16	11	0.108	4.06
446-2I	2	1	25	7/16	11	0.108	4.06
446-215X	2	1 1/2	38	7/16	11	0.108	4.06
446-22X	2	2	51	7/16	11	0.108	4.06
446-215T	2	1 1/2	38	1	25	0.108	4.06
446-22TX	2	2	51	1 1/2	38	0.108	4.06
446-225T	2	2 1/2	64	1 3/4	44	0.108	4.06
446-23T	2	3	76	2 1/4	57	0.108	4.06
446-27X*	2	1	25	7/16	11	0.108	4.06

* For shallow screw recesses see Tool Tip on page 5.

1/4" Hex Insert Bits – ACR®



Part Number	Point Size	Overall Length		
		In.	mm	
440-1-ACR1-RX	1	1	25	
440-1-ACR1-DX	1	1	25	
440-1-ACR1X	1	1	25	
440-2-ACR2-RX	2	1	25	
440-2-ACR2-RI	2	1	25	
440-2-ACR2-DX	2	1	25	
440-2-ACR2X	2	1	25	
446-2-ACR2-DX	2	1	25	Limited Clearance
440-22-ACR2-RX	2	2	51	
440-22-ACR2-DX	2	2	51	
440-22-ACR2X	2	2	51	
440-3-ACR3-RX	3	1	25	
440-3-ACR3-DX	3	1	25	
440-3-ACR3X	3	1	25	

Part number suffix -R
For removal



Part number suffix -D
For driving



No part number suffix
For both removal and driving



5/16" Hex Insert Bits



Part Number	Point Size	Overall Length		
		In.	mm	
480-1X	1	1 1/4	32	
480-2X	2	1 1/4	32	
480-22X	2	2	51	
480-225X	2	2 1/2	64	
480-24X	2	4	101	
480-3X	3	1 1/4	32	
480-325X	3	2 1/2	64	
480-34X	3	4	101	
480-4X	4	1 1/4	32	
480-4BNX	4	1 1/2	38	Large body
480-425X	4	2 1/2	64	

5/16" Hex Insert Bits – ACR®



Part Number	Point Size	Overall Length	
		In.	mm
480-2-ACR2-RX	2	1 1/4	32
480-2-ACR2X	2	1 1/4	32
480-3-ACR3X	3	1 1/4	32
480-4-ACR4X	4	1 1/4	32

Part number suffix -R
For removal



Part number suffix -D
For driving



No part number suffix
For both removal and driving



BOLDED part numbers are industry popular items and are followed by common variations which may vary in price and availability.

ACR® is a trademark of the Phillips Screw Co.

Phillips Bits

5/16" Square Insert Bits



Part Number	Point Size	Overall Length	
		In.	mm
830-1X	1	1 1/8	29
830-2X	2	1 1/8	29
830-3X	3	1 1/8	29
830-4X	4	1 1/8	29

1/4" Hex Power Drive

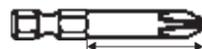

Part Number	Point Size	Overall Length		Body Diameter		Turned Length	
		In.	mm	In.	mm	In.	mm
4910X	0	1 15/16	49	1/8	3.2	1 1/4	32
4910-AX	0	2 3/4	70	1/8	3.2	2	51
4910-BX	0	3 1/2	89	1/8	3.2	2 3/4	70
4910-CX	0	6	152	1/8	3.2	2	51
491X	1	1 15/16	49	3/16	4.8	1 1/4	32
491-AX	1	2 3/4	70	3/16	4.8	2	51
491-BX	1	3 1/2	89	3/16	4.8	2 3/4	70
491-CX	1	6	152	3/16	4.8	2	51
491-CCX	1	6	152	3/16	4.8	5 1/4	133
492X	2	1 15/16	49	1/4	6.4	1 1/4	32
492I	2	1 15/16	49	1/4	6.4	1 1/4	32
492-AX	2	2 3/4	70	1/4	6.4	2	51
492-AI	2	2 3/4	70	1/4	6.4	2	51
492-BX	2	3 1/2	89	1/4	6.4	2 3/4	70
492-BI	2	3 1/2	89	1/4	6.4	2 3/4	70
492-CX	2	6	152	1/4	6.4	2	51
492-CI	2	6	152	1/4	6.4	2	51
492-200MM	2	7 13/16	200	1/4	6.4	7	178
SD-2052-8	2	8	203	9/32	7.1	7	178
SD-2052-10	2	10	254	9/32	7.1	9	229
492-CCX	2	6	152	1/4	6.4	5 1/4	133
492-27X*	2	1 15/16	49	1/4	6.4	1 1/4	32
492-A-27X*	2	2 3/4	70	1/4	6.4	2	51
492-B-27X*	2	3 1/2	89	1/4	6.4	2 3/4	70
492-C-27X*	2	6	152	1/4	6.4	2	51
492-CC-27X*	2	6	152	1/4	6.4	5 1/4	133
493X	3	1 15/16	49	5/16	7.9	1	25
493-AX	3	2 3/4	70	5/16	7.9	1 3/4	44
493-BX	3	3 1/2	89	5/16	7.9	2 1/2	64
493-CX	3	6	152	5/16	7.9	5	127
4930X	3	1 15/16	49	1/4	6.4	1 1/4	32
4930-AX	3	2 3/4	70	1/4	6.4	2	51
4930-BX	3	3 1/2	89	1/4	6.4	2 3/4	70
4930-CX	3	6	152	1/4	6.4	2	51
4930-CCX	3	6	152	1/4	6.4	5 1/4	133
494X	4	1 15/16	49	3/8	9.5	1	25

1/4" Hex Power Drive – ACR®

Part Number	Point Size	Overall Length		Body Diameter		Turned Length	
		In.	mm	In.	mm	In.	mm
491-ACR1-RX	1	1 15/16	49	3/16	4.8	1 1/4	32
491-ACR1-DX	1	1 15/16	49	3/16	4.8	1 1/4	32
491-ACR1X	1	1 15/16	49	3/16	4.8	1 1/4	32
492-ACR2-RX	2	1 15/16	49	1/4	6.4	1 1/4	32
492-ACR2-DX	2	1 15/16	49	1/4	6.4	1 1/4	32
492-ACR2X	2	1 15/16	49	1/4	6.4	1 1/4	32
492-A-ACR2-DX	2	2 3/4	70	1/4	6.4	2	51
492-A-ACR2X	2	2 3/4	70	1/4	6.4	2	51
492-B-ACR2-DX	2	3 1/2	89	1/4	6.4	2 3/4	70
492-B-ACR2X	2	3 1/2	89	1/4	6.4	2 3/4	70
492-C-ACR2-DX	2	6	152	1/4	6.4	2	51
493-ACR3X	3	1 15/16	49	5/16	7.9	1	25



1/4" Hex Power Drive with Finder Sleeve

Part Number	Point Size	Overall Length		Sleeve Diameter	
		In.	mm	In.	mm
SD-556-A	2	3 1/2	89	7/16	11.1
SD-556	2	6	152	7/16	11.1

7/16" Hex Power Drive

Part Number	Point Size	Overall Length		Body Diameter		Turned Length	
		In.	mm	In.	mm	In.	mm
482X	2	3 1/2	89	1/4	6.4	2 1/4	57
483X	3	3 1/2	89	5/16	7.9	2 1/4	57
484X	4	3 1/2	89	3/8	9.5	2 1/4	57

9/32" No. 130A Yankee Drive

Part Number	Point Size	Overall Length		Body Diameter	
		In.	mm	In.	mm
451X	1	3 1/4	83	3/16	4.8
452X	2	3 1/4	83	9/32	7.1
453X	3	3 1/4	83	5/16	7.9

Phillips Bits



10-32 Screw Shank Drive

Part Number	Point Size	Overall Length		Body Diameter	
		In.	mm	In.	mm
501X	1	1 1/2	38	3/16	4.8
501-AX	1	1 13/16	46	3/16	4.8
502X	2	1 1/2	38	1/4	6.4
502-ACR2X*	2	1 1/2	38	1/4	6.4
SD-1342-2	2	1 3/4	45	1/4	6.4
502-AX	2	1 13/16	46	1/4	6.4
503X	3	1 1/2	38	5/16	7.9

*Features ACR® anti-camout ribs. See Tool Tip on page 3.

12-24 Screw Shank Drive



Part Number	Point Size	Overall Length		Body Diameter	
		In.	mm	In.	mm
551X	1	1 3/16	30	.30	7.6
552X	2	1 3/16	30	.30	7.6
552I	2	1 3/16	30	.30	7.6
553X	3	1 3/16	30	.30	7.6

1/4"-24 Screw Shank Drive



Part Number	Point Size	Overall Length		Body Diameter	
		In.	mm	In.	mm
401X	1	1 1/2	38	3/16	4.8
402X	2	1 1/2	38	1/4	6.4
403X	3	1 1/2	38	5/16	7.9

8-32 Screw Shank Drive



Part Number	Point Size	Overall Length		Body Diameter	
		In.	mm	In.	mm
591X	1	1 3/16	30	7/32	5.6
592X	2	1 3/16	30	7/32	5.6

Female Square Service Drive



Part Number	Female Square Drive	Point Size	Overall Length		Body Diameter	
			In.	mm	In.	mm
821	1/4	1	2	51	1/4	6.4
822	1/4	2	2	51	1/4	6.4
832	3/8	2	2 5/8	67	5/16	7.9
833	3/8	3	2 5/8	67	5/16	7.9
834	3/8	4	2 5/8	67	5/16	7.9
852	1/2	2	2 7/8	73	5/16	7.9
853	1/2	3	2 7/8	73	5/16	7.9
854	1/2	4	2 7/8	73	3/8	9.5

If the tool you need does not appear in this catalog, give us a call. The odds are, we may have what you need as a non-catalog item. If not, our experienced staff of tooling experts can design and manufacture "specials" to meet the needs of your specific application. Give us a call at 1-800-845-5629 or visit our website www.apex-tools.com.

BOLDED part numbers are industry popular items and are followed by common variations which may vary in price and availability.

* For shallow screw recesses. See Tool Tip on page 5.

ACR® is a trademark of the Phillips Screw Co.

BOLDED part numbers are industry popular items and are followed by common variations which may vary in price and availability.

Does Apex offer Torx® bits?

Torx® fasteners are becoming more and more common in automotive and appliance assembly. Apex provides a full selection of bits for Torx screws.



(See page 10)

Torx® is a trademark of the Camcar Division of Textron.

Is there an easy way to select a bit?

Take the guesswork out of bit selection. Apex Phillips and Torx® ring gauges help you find the right bit for your fasteners. Order SD-3749 for Phillips and SD-4064-G for Torx®.

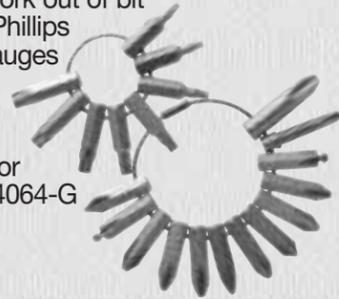

What's the difference between Torx® and Torx Plus® bits?

Torx Plus® bits and fasteners feature a greater engagement area for higher torque transfer and reduced camout when driving Torx Plus® fasteners. They can provide up to 100% more drive cycles. Torx Plus® bits are not compatible with standard Torx® fasteners.



(See pages 10-12)

Torx Plus® is a trademark of the Camcar Division of Textron. Torx Plus® Tamper Resistant Bits are available on a limited basis. Please contact your Area Distributor or Representative for more details.

Does Apex offer fastener tools for the aircraft industry?

Apex offers a full selection of fastener tools common to aircraft assembly and maintenance, including Tri-Wing®, Torq-Set®, Hi-Torque® and Phillips.

(See pages 21-22)



Torq-Set® and ACR® are registered trademarks of the Phillips Screw Co.

What is a finder sleeve?

A finder sleeve makes it easy to engage slotted fasteners with the bit. It guides the bit so there is less "searching" for the proper alignment between blade and slot.



(See page 9)

Why do Apex bits last so much longer than other bits?

Apex's premium tool alloys and proprietary heat treat help avoid typical problems such as shattering and premature bit wear. Most Apex bits are available in three different heat treat hardnesses. Refer to page vi for information on selecting the proper heat treat.

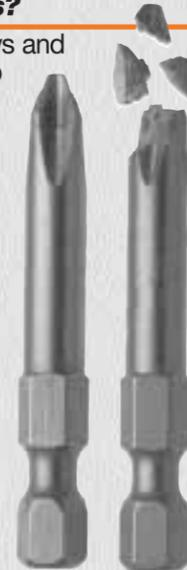

Does Apex offer mar resistant bits and sockets?

Apex can nylon coat just about any of our bits or sockets. Nylon offers excellent mar resistance for assemblies that have painted, varnished or chromed surfaces. Nylon also offers some safety benefits by covering tool junctions.

(See pages 138-146 for more information)

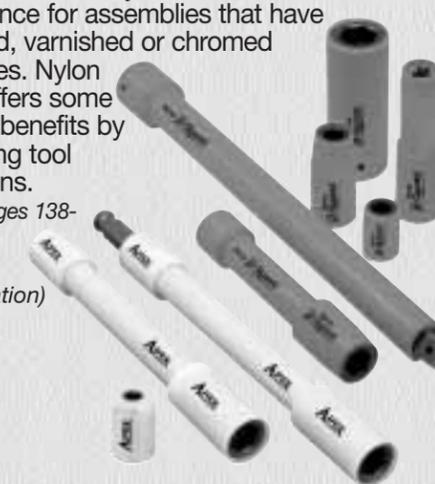

How do Torxalign® bits work?

Torxalign® bits "wedge" into the Torx® recess to firmly hold the fastener to the bit.

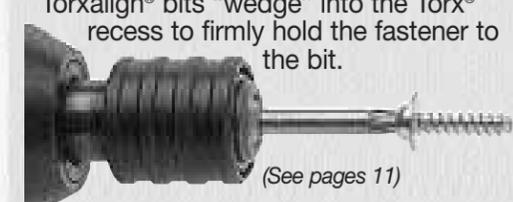

(See pages 11)

What's the difference between a Phillips and a Pozidriv® screw?

The shallow "cross" indentation in the screw head identifies a Pozidriv® fastener. The Pozidriv® bit and recess design provides contact than a standard Phillips for more torque with less possibility of camout.



(See page 13)

If the tool you need does not appear in this catalog, give us a call. The odds are, we may have what you need as a non-catalog item. If not, our experienced staff of tooling experts can design and manufacture "specials" to meet the needs of your specific application. Give us a call at 1-800-845-5629 or visit our website www.apex-tools.com.

Slotted Screw Sizes

Types of Heads

Note: When ordering slotted bits, please remember that head sizes and slot widths of hardened, self tapping, and sheet metal screws do not conform to the same specifications as standard wood or machine screws described in the chart below. Also, because of variations in these dimensions among screws from different manufacturers, bits should be ordered to head and slot size rather than screw size.

Screw Sizes	Diameter of Head						Width of slot	
	Flat Head		Round Head		Truss Head	Binding Head		Fillister Cap Mach.
	Wood	Mach.	Wood	Mach.				
1	.146	.146	.138	.138			.118	.026
	.130	.130	.122	.122			.104	.019
2	.172	.172	.162	.162	.194	.181	.140	.167
	.156	.156	.146	.146	.180	.171	.124	.023
3	.199	.199	.187	.187	.226	.208	.161	.193
	.181	.181	.169	.169	.211	.197	.145	.027
4	.225	.225	.211	.211	.257	.235	.183	.219
	.207	.207	.193	.193	.241	.223	.166	.031
5	.252	.252	.236	.236	.289	.263	.205	.245
	.232	.232	.217	.217	.272	.249	.187	.035
6	.279	.279	.260	.260	.321	.290	.226	.270
	.257	.257	.240	.240	.303	.275	.208	.039
7	.305		.285		.352		.296	.048
	.283		.264		.333		.281	.039
8	.332	.332	.309	.309	.384	.344	.270	.322
	.308	.308	.287	.287	.364	.326	.250	.054
9	.358		.334				.296	.054
	.334		.311				.281	.045
10	.385	.385	.359	.359	.448	.339	.313	.373
	.359	.359	.334	.334	.425	.378	.292	.060
12	.438	.438	.408	.408	.511	.454	.357	.425
	.410	.410	.382	.382	.487	.430	.334	.067
14	.491		.457				.398	.075
	.461		.424				.368	.064
1/4"	.507		.472		.573	.513	.375	.492
	.477		.443		.546	.488	.363	.075
16	.544		.506				.414	.075
	.512		.476				.389	.064
18	.597		.555				.437	.084
	.563		.523				.424	.072
5/16"	.635		.590		.698	.641	.437	.084
	.600		.557		.666	.609	.424	.072
20	.650		.604				.490	.084
	.614		.570				.490	.072
24	.756		.702				.518	.094
	.716		.664				.518	.081
3/8"	.762		.708		.823	.769	.562	.094
	.722		.670		.787	.731	.547	.081

Slotted Bits



1/4" Hex Insert Bits - Limited Clearance

Part Number	Screw Size	Length		Blade Thickness		Blade Width	
		In.	mm	In.	mm	In.	mm
445-000X	1F-2R	1	25	.021	.53	.125	3.2
445-00X	2F-3R	1	25	.025	.64	.140	3.6
445-0X	3F-4R	1	25	.030	.76	.154	3.9
445-10X	4F-5R	1	25	.034	.86	.185	4.7
445-20X	5F-6R	1	25	.036	.91	.216	5.5
445-30X	6F-7R	1	25	.038	.97	.248	6.3
445-00-15X	2F-3R	1 1/2	38	.028	.71	.138	3.5
445-0-15X	3F-4R	1 1/2	38	.032	.81	.154	3.9
445-10-15X	4F-5R	1 1/2	38	.034	.86	.185	4.7
445-20-15X	5F-6R	1 1/2	38	.036	.91	.216	5.5
445-30-15X	6F-7R	1 1/2	38	.038	.97	.248	6.3



1/4" Hex Insert Bits

Part Number	Screw Size	Length		Blade Thickness		Blade Width	
		In.	mm	In.	mm	In.	mm
445-1X	4F-5R	1	25	.034	.86	3/16	4.8
445-2X	6F-8R	1	25	.040	1.02	7/32	5.6
445-3X	8F-10R	1	25	.042	1.07	1/4	6.4
445-4X	10F-12R	1	25	.046	1.17	9/32	7.1
445-1-15X	4F-5R	1 1/2	38	.034	.86	3/16	4.8
445-2-15X	6F-8R	1 1/2	38	.040	1.02	7/32	5.6
445-3-15X	8F-10R	1 1/2	38	.042	1.07	1/4	6.4
445-4-15X	10F-12R	1 1/2	38	.046	1.17	9/32	7.1
445-5X	12F-14R	1 1/2	38	.050	1.27	5/16	7.9
445-6	14F-16R	1 1/2	38	.055	1.40	23/64	9.1



5/16" Hex Insert Bits

Part Number	Screw Size	Length		Blade Thickness		Blade Width	
		In.	mm	In.	mm	In.	mm
485-1X	4F-5R	1 1/2	38	.034	.86	3/16	4.8
485-2X	6F-8R	1 1/2	38	.040	1.02	7/32	5.6
485-3X	8F-10R	1 1/2	38	.042	1.07	1/4	6.4
485-4X	10F-12R	1 1/2	38	.046	1.17	.296	7.52
485-5X	12F-14R	1 1/2	38	.050	1.27	.328	8.33
485-6X	14F-16R	1 1/2	38	.055	1.40	.328	8.33
485-7X	16F-18R	1 3/4	45	.060	1.52	1/2	12.7



1/4" Hex Power Drive

Part Number	Screw Size	Length		Blade Thickness		Blade Width/Body Diameter	
		In.	mm	In.	mm	In.	mm
320-000X	1F-2R	1 15/16	49	.022	.56	.122	3.10
326-000X	1F-2R	2 3/4	70	.022	.56	.122	3.10
323-000X	1F-2R	3	76	.022	.56	.122	3.10
327-000X	1F-2R	3 1/2	89	.022	.56	.122	3.10
324-000X	1F-2R	4	102	.022	.56	.122	3.10
325-000X	1F-2R	5	127	.022	.56	.122	3.10
328-000X	1F-2R	6	152	.022	.56	.122	3.10
320-00X	2F-3R	1 15/16	49	.026	.66	.134	3.40
326-00X	2F-3R	2 3/4	70	.026	.66	.134	3.40
323-00X	2F-3R	3	76	.026	.66	.134	3.40
327-00X	2F-3R	3 1/2	89	.026	.66	.134	3.40
324-00X	2F-3R	4	102	.026	.66	.134	3.40
325-00X	2F-3R	5	127	.026	.66	.134	3.40
328-00X	2F-3R	6	152	.026	.66	.134	3.40
320-0X	3F-4R	1 15/16	49	.030	.76	.151	3.84
326-0X	3F-4R	2 3/4	70	.030	.76	.151	3.84
323-0X	3F-4R	3	76	.030	.76	.151	3.84
327-0X	3F-4R	3 1/2	89	.030	.76	.151	3.84
324-0X	3F-4R	4	102	.030	.76	.151	3.84
325-0X	3F-4R	5	127	.030	.76	.151	3.84
328-0X	3F-4R	6	152	.030	.76	.151	3.84
320-1X	4F-5R	1 15/16	49	.034	.86	.187	4.75
326-1X	4F-5R	2 3/4	70	.034	.86	.187	4.75
323-1X	4F-5R	3	76	.034	.86	.187	4.75
327-1X	4F-5R	3 1/2	89	.034	.86	.187	4.75
324-1X	4F-5R	4	102	.034	.86	.187	4.75
325-1X	4F-5R	5	127	.034	.86	.187	4.75
328-1X	4F-5R	6	152	.034	.86	.187	4.75
320-20X	5F-6R	1 15/16	49	.036	.91	.215	5.46
326-20X	5F-6R	2 3/4	70	.036	.91	.215	5.46
323-20X	5F-6R	3	76	.036	.91	.215	5.46
327-20X	5F-6R	3 1/2	89	.036	.91	.215	5.46
324-20X	5F-6R	4	102	.036	.91	.215	5.46
325-20X	5F-6R	5	127	.036	.91	.215	5.46
328-20X	5F-6R	6	152	.036	.91	.215	5.46
320-2X	5F-6R	1 15/16	49	.036	.91	.250	6.35
326-2X	5F-6R	2 3/4	70	.036	.91	.250	6.35
323-2X	5F-6R	3	76	.036	.91	.250	6.35
327-2X	5F-6R	3 1/2	89	.036	.91	.250	6.35
324-2X	5F-6R	4	102	.036	.91	.250	6.35
325-2X	5F-6R	5	127	.036	.91	.250	6.35
328-2X	5F-6R	6	152	.036	.91	.250	6.35
320-3X	6F-8R	1 15/16	49	.038	.97	.250	6.35
326-3X	6F-8R	2 3/4	70	.038	.97	.250	6.35
323-3X	6F-8R	3	76	.038	.97	.250	6.35
327-3X	6F-8R	3 1/2	89	.038	.97	.250	6.35
324-3X	6F-8R	4	102	.038	.97	.250	6.35
325-3X	6F-8R	5	127	.038	.97	.250	6.35
328-3X	6F-8R	6	152	.038	.97	.250	6.35
320-4X	8F-10R	1 15/16	49	.042	1.07	.275	6.99
326-4X	8F-10R	2 3/4	70	.042	1.07	.275	6.99
323-4X	8F-10R	3	76	.042	1.07	.275	6.99
327-4X	8F-10R	3 1/2	89	.042	1.07	.275	6.99
324-4X	8F-10R	4	102	.042	1.07	.275	6.99
325-4X	8F-10R	5	127	.042	1.07	.275	6.99
328-4X	8F-10R	6	152	.042	1.07	.275	6.99
320-5X	10F-12R	1 15/16	49	.046	1.17	.312	7.92
326-5X	10F-12R	2 3/4	70	.046	1.17	.312	7.92
323-5X	10F-12R	3	76	.046	1.17	.312	7.92
327-5X	10F-12R	3 1/2	89	.046	1.17	.312	7.92
324-5X	10F-12R	4	102	.046	1.17		

Slotted Bits



5/16" Hex Power Drive



Part Number	Screw Size	Length		Blade Thickness		Blade Width/ Body Diameter	
		In.	mm	In.	mm	In.	mm
635-6X	10F-12R	2 1/4	57	.046	1.17	.360	9.14
635-7X	12F-14R	2 1/4	57	.050	1.27	.395	10.03
635-8X	14F-16R	2 1/4	57	.055	1.40	.457	11.61
635-9X	16F-20R	2 1/4	57	.060	1.52	.503	12.78
635-10X	20F-22R	2 1/4	57	.062	1.57	.545	13.84

If the tool you need does not appear in this catalog, give us a call. The odds are, we may have what you need as a non-catalog item. If not, our experienced staff of tooling experts can design and manufacture "specials" to meet the needs of your specific application. Give us a call at 1-800-845-5629 or visit our website www.apex-tools.com.

10-32 Screw Shank Drive



Part Number	Screw Size	Length		Blade Thickness		Blade Width/ Body Diameter	
		In.	mm	In.	mm	In.	mm
103-00X	2F-3R	1 1/2	38	.026	.66	.140	3.56
103-1X	4F-5R	1 1/2	38	.034	.86	.187	4.75
103-2X	5F-6R	1 1/2	38	.036	.91	.225	5.72
103-3X	6F-7R	1 1/2	38	.038	.97	.250	6.35
103-4X	7F-8R	1 1/2	38	.040	1.02	.275	7.24
103-5X	8F-10R	1 1/2	38	.042	1.07	.296	7.52
103-6X	10F-12R	1 1/2	38	.046	1.17	.309	7.85

1/4"-24 Screw Shank Drive



Part Number	Screw Size	Length		Blade Thickness		Blade Width/ Body Diameter	
		In.	mm	In.	mm	In.	mm
309-000X	1F-2R	1 1/2	38	.022	.56	.125	3.18
309-00X	2F-3R	1 1/2	38	.026	.66	.140	3.56
309-1X	4F-5R	1 1/2	38	.034	.86	.187	4.75
309-2X	5F-6R	1 1/2	38	.036	.91	.225	5.72
309-3X	6F-7R	1 1/2	38	.038	.97	.250	6.35
309-4X	7F-8R	1 1/2	38	.040	1.02	.285	7.24
309-5X	8F-10R	1 1/2	38	.042	1.07	.296	7.52
309-6X	10F-12R	1 1/2	38	.046	1.17	.315	8.00
309-8X	14F-16R	1 1/2	38	.055	1.40	.361	9.17

BOLDED part numbers are industry popular items and are followed by common variations which may vary in price and availability.

Slotted Bits



1/4" Power Drive with Finder Sleeves

Each finder sleeve assembly part number begins with a letter prefix that denotes the particular sleeve used with that assembly. The chart below gives complete dimensional data for each finder sleeve.

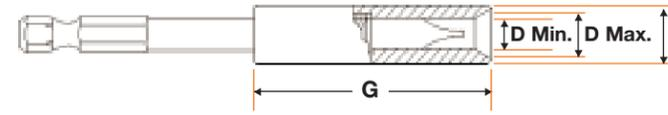

Part No.	Screw Size	D Max.		D Min.		Sleeve Length G		Sleeve Diameter E	
		In.	mm	In.	mm	In.	mm	In.	mm
L	5F-6R	.260	6.60	.233	5.92	1 7/8	47.6	3/8	9.5
M	6F-6R	.309	7.85	.261	6.63	1 7/8	47.6	7/16	11.1
P	8F-6R	.368	9.35	.310	7.87	1 7/8	47.6	1/2	12.7
NP*	8F-10R	.368	9.35	.310	7.87	1 7/8	47.6	7/16	11.1
R	10F-12R	.415	10.54	.369	9.37	2	50.8	9/16	14.3
S	12F-14R	.478	12.14	.416	10.57	2	50.8	5/8	15.9
T	14F-16R	.522	13.26	.479	12.17	2 1/8	54.0	11/16	17.5
U	16F-20R	.621	15.77	.523	13.28	2 1/8	54.0	3/4	19.1
W	20F-22R	.665	16.89	.622	15.80	2 1/16	52.4	13/16	20.3
Y	24F-24R	.715	18.16	.666	16.92	2 1/32	51.6	15/16	23.8

*Sleeve NP is a cup type sleeve.

Slotted Power Bits with Finder Sleeves



1/4" Hex Power Drive

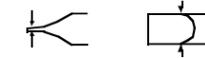

Part No. Complete Assembly	Part No. Bit Only	Screw Size	Bit Length		Blade Thickness		Bit Body Diameter	
			In.	mm	In.	mm	In.	mm
L-320X	320-LX	5F-6R	3 3/4	95	.036	.91	.193	4.90
M-320X	320-MX	6F-8R	3 3/4	95	.038	.97	.241	6.12
P-320X	320-PX	8F-10R	3 3/4	95	.042	1.07	.290	7.37
R-320X	320-RX	10F-12R	3 3/4	95	.046	1.17	.350	8.89
S-320X	320-SX	12F-14R	3 7/8	98	.050	1.27	.395	10.03
T-320X	320-TX	14F-16R	4 1/8	105	.055	1.40	.457	11.61

1/4" Hex Power Drive - Extra Short Series

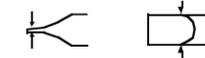

Part No. Complete Assembly	Part No. Bit Only	Screw Size	Bit Length		Blade Thickness		Bit Body Diameter	
			In.	mm	In.	mm	In.	mm
OOL-322X	322-000LX	2F-3R	2 3/32	53	.026	.66	.138	3.91
OOL-322X	-	3F-4R	2 3/32	53	.030	.76	.154	3.91
OL-322X	322-01X	4F-5R	2 5/32	55	.034	.86	.185	4.70
L-322X	-	5F-6R	2 5/32	55	.036	.91	.185	4.70
M-322X	322-MX	6F-8R	2 5/32	55	.040	1.02	.248	6.30
P-322X	-	8F-10R	2 5/32	55	.042	1.07	.283	7.19
R-322X	-	10F-12R	2 5/32	55	.046	1.17	.283	7.19

BOLDED part numbers are industry popular items and are followed by common variations which may vary in price and availability.

1/4" Hex Power Drive - Long Series

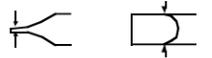

Part No. Complete Assembly	Part No. Bit Only	Screw Size	Bit Length		Blade Thickness		Bit Body Diameter	
			In.	mm	In.	mm	In.	mm
L-328X	328-LX	5F-6R	6 1/2	165	.036	.91	.193	4.90
M-328X	328-MX	6F-8R	6 1/2	165	.038	.97	.241	6.12
P-328X	328-PX	8F-10R	6 1/2	165	.046	1.07	.290	7.37
R-328X	328-RX	10F-12R	6 1/2	165	.046	1.17	.350	8.89
S-328X	328-SX	12F-14R	6 1/2	165	.050	1.27	.395	10.03

7/16" Hex Power Drive with Finder Sleeves

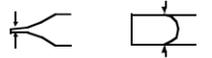

Part Number	Screw Size	Bit Length		Blade Thickness		Bit Body Diameter	
		In.	mm	In.	mm	In.	mm
R-321X	10F-12R	3 7/8	98	.046	1.17	.350	8.89
S-321X	12F-14R	3 7/8	98	.050	1.27	.395	10.03
T-321X	14F-16R	4 1/8	105	.055	1.40	.457	11.61
U-321X	16F-20R	4 1/8	105	.060	1.52	.503	12.78
W-321X	20F-22R	4 1/8	105	.062	1.57	.545	13.84
Y-321X	24F-24R	4 1/8	105	.065	1.65	.595	15.11

See chart on page 14 for sleeve diameters.



1/4" Hex Insert Bits

Part Number	Torxalign® Part Number	Driver Size	Body Diameter In.	Body Diameter mm	Overall Length In.	Overall Length mm
440-TX-05X	-	T-5	.055	1	25	
440-TX-06X	-	T-6	.065	1	25	
440-TX-07X	-	T-7	.077	1	25	
440-TX-08X	-	T-8	.090	1	25	
440-TX-09X	-	T-9	.097	1	25	
440-TX-10X	440-TX-10-W	T-10	.107	1	25	
440-TX-15X	440-TX-15-W	T-15	.128	1	25	
440-TX-15-125	-	T-15	.128	1 1/4	32	
440-TX-20X	440-TX-20-W	T-20	.151	1	25	
440-TX-20-125	-	T-20	.151	1 1/4	32	
440-TX-20-2	-	T-20	.151	2	51	
440-TX-25X	440-TX-25-W	T-25	.173	1	25	
440-TX-27X	440-TX-27-W	T-27	.195	1	25	
440-TX-30X	440-TX-30-W	T-30	.216	1	25	
440-TX-40X	440-TX-40-W	T-40	.260	1	25	
440-TX-40I	440-TX-40-W	T-40	.260	1	25	
440-TX-45X*	-	T-45	.306	1 1/4	32	
440-TX-50X*	-	T-50	.346	1 1/4	32	

*Hex will break before rated ultimate torque of the Torx® point is met.



1/4" Hex Insert Bits – Tamper Resistant**

Part Number	Driver Size	A (Ref.)	Body Diameter In.	Body Diameter mm	Overall Length In.	Overall Length mm
440-TX-07-H	T-7-H	.077	1	25		
440-TX-08-H	T-8-H	.090	1	25		
440-TX-09-H	T-9-H	.097	1	25		
440-TX-10-H	T-10-H	.107	1	25		
440-TX-15-H	T-15-H	.128	1	25		
440-TX-20-H	T-20-H	.151	1	25		
440-TX-25-H	T-25-H	.173	1	25		
440-TX-27-H	T-27-H	.195	1	25		
440-TX-30-H	T-30-H	.216	1	25		
440-TX-40-H	T-40-H	.260	1	25		

** Tamper resistant Torx® screws feature a post in the center of the recess—this post will only fit into a tamper resistant Torx® bit. Tamper resistant Torx® bits are available on a restricted distribution basis. Contact your local Apex representative for details.

BOLDED part numbers are industry popular items and are followed by common variations which may vary in price and availability.



5/16" Hex Insert Bits

Part Number	Driver Size	Body Diameter In.	Body Diameter mm	Overall Length In.	Overall Length mm
480-TX-20X	T-20	.151	1 1/4	32	
480-TX-25X	T-25	.173	1 1/4	32	
480-TX-27X	T-27	.195	1 1/4	32	
480-TX-30X	T-30	.216	1 1/4	32	
480-TX-40X	T-40	.260	1 1/4	32	
480-TX-40-4X	T-40	.260	4	102	
480-TX-45X	T-45	.306	1 1/4	32	
480-TX-45-6	T-45	.306	6	152	
480-TX-50X	T-50	.346	1 1/4	32	
480-TX-55X	T-55	.440	1 1/4	32	



5/16" Hex Insert Bits – Tamper Resistant**

Part Number	Driver Size	Body Diameter In.	Body Diameter mm	Overall Length In.	Overall Length mm
480-TX-40-H	T-40-H	.260	1 1/4	32	
480-TX-45-H	T-45-H	.306	1 1/4	32	
480-TX-50-H	T-50-H	.346	1 1/4	32	
480-TX-55-H	T-55-H	.440	1 1/4	32	

**Tamper resistant Torx® bits are available on a restricted distribution basis. Contact your local Apex representative for details.



5/8" Hex Insert Bits

Part Number	Hex Flat Type*	Driver Size	Body Diameter In.	Body Diameter mm	Overall Length In.	Overall Length mm
SZ-TX-55-A	DP	T-55	.440	1 9/16	40	
SZ-TX-60-A	DP	T-60	.520	1 9/16	40	
SZ-TX-70-A	DP	T-70	.610	1 9/16	40	
SZ-TX-70-A-3	TH	T-70	.610	3	76	
SZ-TX-80-A	TH	T-80	.689	1 9/16	40	

*DP-Drill Point; TH-Thru Hole. 5/8" insert bits are used with SC and RP adapters found on pages 51.



7/8" Hex Insert Bits

Part Number	Hex Flat Type*	Driver Size	Body Diameter In.	Body Diameter mm	Overall Length In.	Overall Length mm
SZ-TX-90-A	TH	T-90	.782	2	51	
SZ-TX-100-A	TH	T-100	.870	2	51	

*TH-Thru Hole. 7/8" insert bits are used with RP adapters found on pages 51.



1/4" Hex Power Drive

Part Number	Driver Size	Body Diameter In.	Body Diameter mm	Overall Length In.	Overall Length mm
49-TX-05	T-5	.055	.119	3.0	1 15/16 49
49-A-TX-05	T-5	.055	.119	3.0	2 3/4 70
49-B-TX-05	T-5	.055	.119	3.0	3 1/2 89
49-TX-06	T-6	.065	.119	3.0	1 15/16 49
49-A-TX-06	T-6	.065	.119	3.0	2 3/4 70
49-TX-07	T-7	.077	.119	3.0	1 15/16 49
49-A-TX-07	T-7	.077	.119	3.0	2 3/4 70
49-B-TX-07	T-7	.077	.119	3.0	3 1/2 89
49-C-TX-07	T-7	.077	.119	3.0	6 152
49-TX-08	T-8	.090	.119	3.0	1 15/16 49
49-A-TX-08	T-8	.090	.119	3.0	2 3/4 70
49-B-TX-08	T-8	.090	.119	3.0	3 1/2 89
49-C-TX-08	T-8	.090	.119	3.0	6 152
49-TX-09	T-9	.097	.119	3.0	1 15/16 49
49-A-TX-09	T-9	.097	.119	3.0	2 3/4 70
49-B-TX-09	T-9	.097	.119	3.0	3 1/2 89
49-C-TX-09	T-9	.097	.119	3.0	6 152
49-TX-10	T-10	.107	.150	3.8	1 15/16 49
49-A-TX-10	T-10	.107	.150	3.8	2 3/4 70
SD-4693	T-10	.107	.150	3.8	3 75
49-B-TX-10	T-10	.107	.150	3.8	3 1/2 89
49-C-TX-10	T-10	.107	.150	3.8	6 152
49-TX-15	T-15	.128	.150	3.8	1 15/16 49
49-A-TX-15	T-15	.128	.150	3.8	2 3/4 70
49-B-TX-15	T-15	.128	.150	3.8	3 1/2 89
49-C-TX-15	T-15	.128	.150	3.8	6 152
49-TX-20	T-20	.151	.171	4.3	1 15/16 49
49-A-TX-20	T-20	.151	.171	4.3	2 3/4 70
49-B-TX-20	T-20	.151	.171	4.3	3 1/2 89
49-TX-20-5	T-20	.151	.171	4.3	5 127
49-C-TX-20	T-20	.151	.171	4.3	6 152
49-TX-25	T-25	.173	.193	4.9	1 15/16 49
49-A-TX-25	T-25	.173	.193	4.9	2 3/4 70
49-B-TX-25	T-25	.173	.193	4.9	3 1/2 89
49-C-TX-25	T-25	.173	.193	4.9	6 152
49-TX-27	T-27	.195	.215	5.5	1 15/16 49
49-A-TX-27	T-27	.195	.215	5.5	2 3/4 70
49-B-TX-27	T-27	.195	.215	5.5	3 1/2 89
49-C-TX-27	T-27	.195	.215	5.5	6 152
49-TX-30	T-30	.216	.236	6.0	1 15/16 49
49-A-TX-30	T-30	.216	.236	6.0	2 3/4 70
49-B-TX-30	T-30	.216	.236	6.0	3 1/2 89
49-C-TX-30	T-30	.216	.236	6.0	6 152
49-TX-40	T-40	.260	.309	7.8	1 15/16 49
49-A-TX-40	T-40	.260	.309	7.8	2 3/4 70
49-B-TX-40	T-40	.260	.309	7.8	3 1/2 89
49-C-TX-40	T-40	.260	.309	7.8	6 152

BOLDED part numbers are industry popular items and are followed by common variations which may vary in price and availability.



1/4" Hex Power Drive – Torxalign®

Part Number	Driver Size	Body Diameter In.	Body Diameter mm	Overall Length In.	Overall Length mm
49-TX-08-W	T-8	.090	.119	3.0	1 15/16 49
49-TX-10-W	T-10	.107	.150	3.8	1 15/16 49
49-TX-15-W	T-15	.128	.150	3.8	1 15/16 49
49-A-TX-15-W	T-15	.128	.150	3.8	2 3/4 70
49-B-TX-15-W	T-15	.128	.150	3.8	3 1/2 89
49-TX-20-W	T-20	.151	.171	4.3	1 15/16 49
49-B-TX-20-W	T-20	.151	.171	4.3	3 1/2 89
49-TX-25-W	T-25	.173	.193	4.9	1 15/16 49
49-TX-27-W	T-27	.195	.215	5.5	1 15/16 49
49-TX-30-W	T-30	.216	.236	6.0	1 15/16 49
49-B-TX-30-W	T-30	.216	.236	6.0	3 1/2 89



1/4" Hex Power Drive – Tamper Resistant**

Part Number	Driver Size	Body Diameter In.	Body Diameter mm	Overall Length In.	Overall Length mm
49-TX-10-H	T-10-H	.107	.150	3.8	1 15/16 49
49-A-TX-10-H	T-10-H	.107	.150	3.8	2 3/4 70
49-TX-15-H	T-15-H	.128	.150	3.8	1 15/16 49
49-A-TX-15-H	T-15-H	.128	.150	3.8	2 3/4 70
49-B-TX-15-H	T-15-H	.128	.150	3.8	3 1/2 89
49-A-TX-20-H	T-20-H	.151	.171	4.3	2 3/4 70
49-B-TX-20-H	T-20-H	.151	.171	4.3	3 1/2 89
49-C-TX-20-H	T-20-H	.151	.171	4.3	6 152

**Tamper resistant Torx® bits are available on a restricted distribution basis. Contact your local Apex representative for details.



1/4" Hex Power Drive with Finder Sleeves

Part Number	Driver Size	Sleeve Number*	Sleeve Diameter In.	Sleeve Diameter mm	Overall Length In.	Overall Length mm
M-32-TX-15	T-15	M	.128	.437	12.1	3 1/2 89
M-32-TX-20	T-20	M	.151	.437	12.1	3 1/2 89
NP-32-TX-25	T-25	NP	.173	.437	12.1	3 3/4 95
R-32-TX-27	T-27	R	.195	.563	14.3	3 5/8 92
S-32-TX-30	T-30	S	.216	.625	15.9	3 7/8 98

*See page 14 for Sleeve Selection



7/16" Hex Power Drive

Part Number	Driver Size	Body Diameter In.	Body Diameter mm	Overall Length In.	Overall Length mm
48-TX-40	T-40	.260	.277	7.0	3 1/2 89
48-TX-45	T-45	.306	.323	8.2	3 1/2 89
48-TX-50	T-50	.346	.363	9.2	3 1/2 89
48-TX-55	T-55	.440	.503	12.8	3 3/4 95

Torx® Bits



10-32 Screw Shank Drive

Part Number	Driver Size	Point Size	Body Diameter		Overall Length	
			In.	mm	In.	mm
50-TX-08	T-8	.090	.125	3.2	1 1/2	38
50-TX-10	T-10	.107	.150	3.8	1 1/2	38
50-TX-15	T-15	.128	.150	3.8	1 1/2	38
50-TX-20	T-20	.151	.171	4.3	1 1/2	38



12-24 Screw Shank Drive

Part Number	Driver Size	Point Size	Body Diameter		Overall Length	
			In.	mm	In.	mm
55-TX-10	T-10	.107	.150	3.8	1 3/16	30
55-TX-15	T-15	.128	.150	3.8	1 3/16	30
SD-4048	T-15	.128	.309	7.8	1 3/16	30
55-TX-20	T-20	.151	.171	4.3	1 3/16	30
55-TX-25	T-25	.173	.193	4.9	1 3/16	30
55-TX-30	T-30	.216	.309	7.8	1 3/16	30



Female Square Service Drive

Part Number	Driver Size	Point Size	Square Drive	Body Diameter		Overall Length	
				In.	mm	In.	mm
834-TX-25	T-25	.173	3/8	.240	6.1	2 13/16	71
834-TX30-1.62	T-30	.216	3/8	.234	5.9	1 5/8	41
834-TX40-2.95	T-40	.260	3/8	.277	7.0	2 61/64	75
834-TX50-1.62	T-50	.346	3/8	.373	9.4	1 1/4	41
834-TX-45-5	T-45	.306	3/8	.323	8.2	5	125
834-TX-50	T-50	.346	3/8	.363	9.2	2 5/8	66
854-TX-50	T-50	.346	1/2	.323	8.2	2 7/8	73
854-TX-55-150M	T-55	.346	1/2	.363	9.2	5 7/8	150



1" Square Drive Adapters with Torx® Insert Bit

Part Number	Driver Size	Point Size	Overall Length		Bit Length (B)	
			In.	mm	In.	mm
SZ-8L-TX-70	T-70	.610	3 19/32	91	.90	23
SZ-TX-100	T-100	.870	3 19/32	91	1.13	29

Torx Plus® Bits



1/4" Hex Insert Bits

Part Number	Driver Size	Point Size	Overall Length	
			In.	mm
440-10IPX	10IP	.107	1	25
440-15IPX	15IP	.128	1	25
440-20IPX	20IP	.151	1	25
440-25IPX	25IP	.173	1	25
440-27IPX	27IP	.195	1	25
440-30IPX	30IP	.216	1	25
440-40IPX	40IP	.260	1	25



1/4" Hex Insert Bits - Tamper Resistant**

Part Number	Driver Size	Point Size	Overall Length	
			In.	mm
440-10IPRX	10IPR	.107	1	25
440-15IPRX	15IPR	.128	1	25
440-20IPRX	20IPR	.151	1	25
440-25IPRX	25IPR	.173	1	25
440-27IPRX	27IPR	.195	1	25
440-30IPRX	30IPR	.216	1	25
440-40IPRX	40IPR	.260	1	25

**Tamper resistant Torx Plus® bits are available on a restricted distribution basis. Contact your local Apex representative for details.



1/4" Hex Power Drive

Part Number	Driver Size	Point Size	Overall Length	
			In.	mm
49-10IPX	10IP	.107	1 15/16	49
49-A-10IPX	10IP	.107	2 3/4	70
49-B-10IPX	10IP	.107	3 1/2	89
49-15IPX	15IP	.128	1 15/16	49
49-A-15IPX	15IP	.128	2 3/4	70
49-B-15IPX	15IP	.128	3 1/2	89
49-20IPX	20IP	.151	1 15/16	49
49-A-20IPX	20IP	.151	2 3/4	70
49-B-20IPX	20IP	.151	3 1/2	89
49-25IPX	25IP	.173	1 15/16	49
49-A-25IPX	25IP	.173	2 3/4	70
49-B-25IPX	25IP	.173	3 1/2	89
49-27IPX	27IP	.195	1 15/16	49
49-A-27IPX	27IP	.195	2 3/4	70
49-B-27IPX	27IP	.195	3 1/2	89
49-30IPX	30IP	.216	1 15/16	49
49-A-30IPX	30IP	.216	2 3/4	70
49-B-30IPX	30IP	.216	3 1/2	89
49-40IPX	40IP	.260	1 15/16	49

Torx Plus® Bits



1/4" Hex Power Drive - Tamper Resistant

Part Number	Driver Size	Point Size	Overall Length	
			In.	mm
49-10IPRX	10IPR	.107	1 15/16	49
49-15IPRX	15IPR	.128	1 15/16	49
49-20IPRX	20IPR	.151	1 15/16	49
49-25IPRX	25IPR	.173	1 15/16	49
49-27IPRX	27IPR	.195	1 15/16	49
49-30IPRX	30IPR	.216	1 15/16	49
49-40IPRX	40IPR	.260	1 15/16	49

**Tamper resistant Torx Plus® bits are available on a restricted distribution basis. Contact your local Apex representative for details.

Pozidriv® Bits



1/4" Hex Insert Bits

Part Number	Point Size	Overall Length	
		In.	mm
440-1-PZDX	1	1	25
440-2-PZDX	2	1	25
440-215-PZDX	2	1 1/2	38
440-22-PZDX	2	2	51
440-3-PZDX	3	1	25
440-4-PZDX	4	1 1/4	32



1/4" Hex Insert Bits - Limited Clearance

Part Number	Point Size	Overall Length		Turned Length (A)		Turned OD (B)	
		In.	mm	In.	mm	In.	mm
446-1-PZDX	1	1	25.4	7/16	11	0.18	4.6
446-2-PZDX	2	1	25.4	7/16	11	0.18	4.6



5/16" Hex Insert Bits

Part Number	Point Size	Overall Length	
		In.	mm
480-1-PZDX	1	1 1/4	32
480-2-PZDX	2	1 1/4	32
480-3-PZDX	3	1 1/4	32



1/4" Hex Power Drive

Part Number	Point Size	Overall Length		Body Diameter		Turned Length	
		In.	mm	In.	mm	In.	mm
491-PZDX	1	1 15/16	49	3/16	4.8	1 1/4	32
491-A-PZDX	1	2 3/4	70	3/16	4.8	2	51
491-B-PZDX	1	3 1/2	89	3/16	4.8	2 3/4	70
491-C-PZDX	1	6	152	3/16	4.8	2	51
492-PZDX	2	1 15/16	49	1/4	6.4	1 1/4	32
492-A-PZDX	2	2 3/4	70	1/4	6.4	2	51
492-B-PZDX	2	3 1/2	89	1/4	6.4	2 3/4	70
492-C-PZDX	2	6	152	1/4	6.4	2	51
493-PZDX	3	1 15/16	49	5/16	7.9	1	25
493-A-PZDX	3	2 3/4	70	5/16	7.9	1 3/4	44
493-B-PZDX	3	3 1/2	89	5/16	7.9	2 1/4	57
493-C-PZDX	3	6	152	5/16	7.9	5	127



1/4"-24 Screw Shank Drive

Part Number	Point Size	Overall Length		Body Diameter	
		In.	mm	In.	mm
401-PZDX	1	1 1/2	38	3/16	4.8
402-PZDX	2	1 1/2	38	1/4	6.4
403-PZDX	3	1 1/2	38	5/16	7.9



8-32 Screw Shank Drive

Part Number	Point Size	Overall Length		Body Diameter	
		In.	mm	In.	mm
591-PZDX	1	1 3/16	30	7/32	5.6
592-PZDX	2	1 3/16	30	7/32	5.6



10-32 Screw Shank Drive

Part Number	Point Size	Overall Length		Body Diameter	
		In.	mm	In.	mm
502-PZDX	2	1 1/2	38	1/4	6.4
SD-1342-2-PZDX	2	1 3/4	45	1/4	6.4

BOLDED part numbers are industry popular items and are followed by common variations which may vary in price and availability.

Torx®, Torx Plus® and Torxalign® are registered trademarks of the Camcar Division of Textron.

Torx Plus® Tamper Resistant Bits are available on a limited basis. Please contact your Area Distributor or Representative for more details.

BOLDED part numbers are industry popular items and are followed by common variations which may vary in price and availability.

Pozidriv® is a registered trademark of the Phillips Screw Company.

Sel-O-Fit Bits



1/4" Hex Insert Bits

Part Number	Point Size	Overall Length	
		In.	mm
440-1-SFX	1	1	25
440-2-SFX	2	1	25
440-215-SFX	2	1 1/2	38
440-22-SFX	2	2	51
440-225-SFX	2	2 1/2	64
440-3-SFX	3	1	25

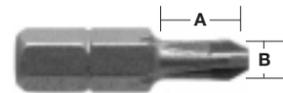

1/4" Hex Insert Bits – Limited Clearance

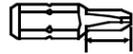

Part Number	Point Size	Overall Length	Turned Length (A)		Turned OD (B)	
		In.	In.	mm	In.	mm
446-2-SFX	2	1	7/16	11	0.18	4.6



5/16" Hex Insert Bits

Part Number	Point Size	Overall Length	
		In.	mm
480-2-SFX	2	1 1/4	32



1/4" Hex Power Drive



Part Number	Point Size	Overall Length		Body Diameter		Turned Length	
		In.	mm	In.	mm	In.	mm
491-SFX	1	1 15/16	49	3/16	5	1 1/4	32
491-A-SFX	1	2 3/4	70	3/16	5	2	51
491-B-SFX	1	3 1/2	89	3/16	5	2 3/4	70
491-C-SFX	1	6	152	3/16	5	2	51
492-SFX	2	1 15/16	49	1/4	6	1 1/4	32
492-A-SFX	2	2 3/4	70	1/4	6	2	51
492-B-SFX	2	3 1/2	89	1/4	6	2 3/4	70
492-C-SFX	2	6	152	1/4	6	2	51

Sel-O-Fit® bits are designed to provide a more efficient means of driving Pozidriv® screws.

The Sel-O-Fit bit places torque on the strongest and most mechanically advantageous portion of the driver tip.

This allows more torque to be applied while minimizing the possibility of breakage and camout.

Sel-O-Fit® is a registered trademark of Cooper Industries.

BOLDED part numbers are industry popular items and are followed by common variations which may vary in price and availability.

If the tool you need does not appear in this catalog, give us a call. The odds are, we may have what you need as a non-catalog item. If not, our experienced staff of tooling experts can design and manufacture "specials" to meet the needs of your specific application. Give us a call at 1-800-845-5629 or visit our website www.apex-tools.com.

Frearson Bits

1/4" Hex Insert Bits



Part Number	Point Size	Overall Length	
		In.	mm
440-FX	All	1	25
446-FX	All	1	25

For limited clearance

5/16" Hex Insert Bit



Part Number	Point Size	Overall Length	
		In.	mm
480-FX	All	1 3/8	35



1/4" Hex Power Drive

Part Number	Screw Size	Overall Length		Body Diameter		Turned Length	
		In.	mm	In.	mm	In.	mm
491-FX	All	1 15/16	49	3/16	5	1 1/4	32
491-AFX	All	2 3/4	70	3/16	5	2	51
491-BFX	All	3 1/2	89	3/16	5	2 3/4	70
491-CFX	All	6	152	3/16	5	2	51
492-FX	All	1 15/16	49	1/4	6	1 1/4	32
492-AFX	All	2 3/4	70	1/4	6	2	51
492-BFX	All	3 1/2	89	1/4	6	2 3/4	70
492-CFX	All	6	152	1/4	6	2	51
493-FX	All	1 15/16	49	5/16	8	1	25
493-BFX	All	3 1/2	89	5/16	8	2 1/2	64

The Frearson recess is designed so that any size bit will fit any size recess. Choose bits on the basis of body diameter – the larger the screw, the larger the body diameter.

12-24 Screw Shank Drive



Part Number	Screw Size	Overall Length		Body Diameter	
		In.	mm	In.	mm
552-FX	All	1 3/16	30	.30	8



1/4" Female Square Drive

Part Number	Screw Size	Overall Length		Body Diameter	
		In.	mm	In.	mm
822-FX	All	2	51	1/4	6



3/8" Female Square Drive

Part Number	Screw Size	Overall Length		Body Diameter	
		In.	mm	In.	mm
832-FX	All	2 5/8	67	1/4	6
833-FX	All	2 5/8	67	5/16	8
834-FX	All	2 5/8	67	3/8	10

BOLDED part numbers are industry popular items and are followed by common variations which may vary in price and availability.

ACR® is a trademark of the Phillips Screw Co.

B.N.A.E. Bits



1/4" Hex Insert Bits



Part Number	Point Size	Overall Length	
		In.	mm
BNAE-3mm	3mm	1 1/8	29
BNAE-4mm	4mm	1 1/8	29
BNAE-5mm	5mm	1 1/8	29
BNAE-6mm	6mm	1 1/8	29
BNAE-8mm	8mm	1 1/8	29

1/4" Hex Insert Bits – ACR®



Part Number	Point Size	Overall Length	
		In.	mm
BNAE-4mm-ACR	4mm	1 1/8	29
BNAE-5mm-ACR	5mm	1 1/8	29
BNAE-6mm-ACR	6mm	1 1/8	29



ACR® ribs for both removal and driving

Socket Head Sizing Chart

SAE									
Nominal Hex Size, Inches	Socket Head Cap Screws 1960 Series	Socket Head Cap Screws 1936 Series	Flat Head Cap Screws	Button Head Cap Screws	Set Screws	Shoulder Screws	Pressure Plugs	Allenuts	Low Head Cap Screws
.050	0	0, 1	1, 2	3, 4	—	—	—	4	.050
1/16	1	2	3, 4	3, 4	5, 6	—	—	—	5, 6
5/64	2, 3	3, 4	5, 6	5, 6	8	—	—	—	8
3/32	4, 5	5, 6	8	8	10	—	—	—	10
7/64	6	—	—	—	—	—	—	—	—
1/8	—	8	10	10	1/4	1/4	—	4, 5	1/4
9/64	8	10	—	—	—	—	—	—	—
5/32	10	1/4	1/4	1/4	5/16	5/16	1/16	6	5/16
3/16	1/4	—	5/16	5/16	3/8	3/8	1/8	8, 10	3/8
7/32	—	5/16	3/8	3/8	7/16	—	—	—	7/16
1/4	5/16	—	7/16	—	1/2	1/2	1/4	1/4	1/2
5/16	3/8	3/8, 7/16	1/2	—	5/8	5/8	3/8	5/16	5/8
3/8	7/16, 1/2	1/2	5/8	—	3/4	3/4	1/2	3/8	—
7/16	—	—	—	—	—	—	—	7/16	—
1/2	5/8	5/8	3/4	—	7/8	1	—	1/2	—
9/16	—	3/4, 7/8	7/8	—	1, 1 1/8	—	3/4	—	—
5/8	3/4	1	1	—	1 1/4, 1 3/8	1 1/4	1	5/8	—
3/4	7/8, 1	1 1/8, 1 1/4, 1 3/8	1 1/8	—	1 1/2	—	1 1/4	3/4	—
7/8	1 1/8, 1 1/4	—	1 1/4, 1 3/8	—	—	1 1/2	—	7/8	—
1	1 3/8, 1 1/2	1 1/2	1 1/2	—	1 3/4, 2	1 3/4	1 1/2, 2	1	—
1 1/4	1 3/4	—	—	—	—	2	—	1 1/4	—
1 1/2	2	—	—	—	—	—	—	1 1/2	—
1 3/4	2 1/4, 2 1/2	—	—	—	—	—	—	—	1 3/4
2	2 3/4	—	—	—	—	—	—	—	—

Metric							
Nominal hex Size, MM	Socket Head Cap Screws	Flat Head Cap Screws	Button Head Cap Screws	Set Screws	Shoulder Screws	Allenuts	Low Head Cap Screws
1.5	M1.6, M1.7, M2	—	—	M3	—	—	—
2	M2.3, M2.5, M2.6	M3	M3	M4	—	—	—
2.5	M3	M4	M4	M5	—	—	—
3	M4	M5	M5	M6	6mm	M3	M4
4	M5	M6	M6	M8	8mm	M4	M5
5	M6	M8	M8	M10	10mm	M5	M6
6	M8	M10	M10	M12, M14	12mm	M6	M8
8	M10	M12	M12	M16	16mm	M8	M10
10	M12	M14, M16	—	M20	20mm	M10	M12
12	M14	M20	—	M24	—	M12	M14
14	M16	—	—	—	—	—	M16
17	M20	—	—	—	—	M16	M20, M22
19	M24	—	—	—	—	—	M24

Socket Head Bits

1/4" Hex Insert Bits

Part Number	Hex Size	Overall Length	
		In.	mm
185-000X	.050	1	25
185-00X	1/16	1	25
185-0X	5/64	1	25
185-1X	3/32	1	25
185-9X	7/64	1	25
185-2X	1/8	1	25
185-10X	9/64	1	25
185-3X	5/32	1 5/16	33
185-4X	3/16	1 5/16	33
185-4-4X	3/16	4	102
185-5X	7/32	1 5/16	33
185-6X	1/4	1 5/16	33
185-7X	5/16	1 1/4	32
185-8X	3/8	1 1/4	32

1/4" Hex Insert Bits – Metric

Part Number	Hex Size	Overall Length	
		In.	mm
185-1.5mm	1.5mm	1	25
185-2mm	2mm	1	25
185-2.5mm	2.5mm	1	25
185-3mm	3mm	1	25
185-4mm	4mm	1 5/16	33
185-5mm	5mm	1 5/16	33
185-6mm	6mm	1 5/16	33
185-7mm	7mm	1 1/4	32
185-8mm	8mm	1 1/4	32
185-9mm	9mm	1 1/4	32
185-10mm	10mm	1 1/4	32

5/16" Hex Insert Bits

Part Number	Hex Size	Overall Length	
		In.	mm
315-3X	5/32	1 5/16	33
315-4X	3/16	1 5/16	33
315-5X	7/32	1 5/16	33
315-6X	1/4	1 5/16	33
315-7X	5/16	1 5/16	33
315-8X	3/8	1 5/16	33

5/16" Hex Insert Bits – Metric

Part Number	Hex Size	Overall Length	
		In.	mm
315-2.5mm	2.5mm	1	25
315-4mm	4mm	1 5/16	33
315-5mm	5mm	1 5/16	33
315-6mm	6mm	1 5/16	33
315-7mm	7mm	1 5/16	33
315-8mm	8mm	1 5/16	33
315-10mm	10mm	1 3/8	35
315-12mm	12mm	1 1/4	32
315-14mm	14mm	1 1/4	32

BOLDED part numbers are industry popular items and are followed by common variations which may vary in price and availability.



1/4" Hex Power Drive

Part Number	Hex Size	Overall Length	
		In.	mm
AM-02	1/16	1 15/16	49
AM-02-A	5/64	1 15/16	49
AM-03	3/32	1 15/16	49
AM-03-3	3/32	3	76
AM-03-6	3/32	6	152
AM-03-A	7/64	1 15/16	49
AM-04	1/8	1 15/16	49
AM-04-3	1/8	3	76
AM-04-35	1/8	3 1/2	89
AM-04-4	1/8	4	102
AM-04-5	1/8	5	127
AM-04-6	1/8	6	152
AM-04-A	9/64	1 15/16	49
AM-04-A-4	9/64	4	102
AM-05	5/32	1 15/16	49
AM-05-3	5/32	3	76
AM-05-35	5/32	3 1/2	89
AM-05-4	5/32	4	102
AM-05-5	5/32	3	127
AM-05-6	5/32	6	152
AM-05-8	5/32	8	203
AM-06	3/16	1 15/16	49
AM-06-3	3/16	3	76
AM-06-4	3/16	4	102
AM-06-6	3/16	6	152
AM-07	7/32	1 15/16	49
AM-08	1/4	1 15/16	49
AM-10	5/16	1 15/16	49

1/4" Hex Power Drive – Metric

Part Number	Hex Size	Overall Length	
		In.	mm
AM-1.5mm	1.5mm	1 15/16	49
AM-2mm	2mm	1 15/16	49
AM-2.5mm	2.5mm	1 15/16	49
AM-3mm	3mm	1 15/16	49
AM-3mm-3	3mm	3	76
AM-3mm-4	3mm	4	102
AM-4mm	4mm	1 15/16	49
AM-5mm	5mm	1 15/16	49
AM-5mm-4	5mm	4	102
AM-6mm	6mm	1 15/16	49
AM-6mm-4	6mm	4	102
AM-7mm	7mm	1 15/16	49
AM-8mm	8mm	1 15/16	49
AM-10mm	10mm	1 15/16	49

5/16" Hex Power Drive

Part Number	Hex Size	Overall Length	
		In.	mm
AS-06	3/16	3	76
AS-10	5/16	3	76
AS-12	3/8	3	76

Socket Head Bits

7/16" Hex Power Drive

Part Number	Hex Size	Overall Length	
		In.	mm
AN-04	1/8	3 1/2	89
AN-04-A	9/64	3 1/2	89
AN-05	5/32	3 1/2	89
AN-05-6	5/32	6	152
AN-06	3/16	3 1/2	89
AN-06-6	3/16	6	152
AN-07	7/32	3 1/2	89
AN-07-8	7/32	8	203
AN-08	1/4	3 1/2	89
AN-08-8	1/4	8	203
AN-09	9/32	3 1/2	89
AN-10	5/16	3 1/2	89
AN-10-6	5/16	6	152
AN-12	3/8	3 1/2	89
AN-12-6	3/8	6	152
AN-16	1/2	3 1/2	89
AN-16-6	1/2	6	152

7/16" Hex Power Drive—Metric

Part Number	Size	Hex	Overall Length	
			In.	mm
AN-3mm	3mm		3 1/2	89
AN-4mm	4mm		3 1/2	89
AN-5mm	5mm		3 1/2	89
AN-6mm	6mm		3 1/2	89
AN-8mm	8mm		3 1/2	89
AN-10mm	10mm		3 1/2	89
AN-12mm	12mm		3 1/2	89
AN-14mm	14mm		3 1/2	89
AN-14mm-6	14mm		6	152

5/8" Hex Power Drive

Part Number	Hex Size	Overall Length	
		In.	mm
AP-08	1/4	4	102
AP-10	5/16	4	102
AP-12	3/8	4	102
AP-16	1/2	4	102
AP-18	9/16	4	102
AP-20	5/8	4	102
AP-24	3/4	4	102

BOLDED part numbers are industry popular items and are followed by common variations which may vary in price and availability.

Socket Head Bits with Square Drive Adapters, SAE

3/8" Square Drive

Part Number		Hex Size	Overall Length		Length of Insert		
Adapter Only	Insert Only		In.	mm	In.	mm	
SZ-9	SC-314	SZ-9-A	3/32	2 1/4	57	1 3/8	35
SZ-7	SC-314	SZ-7-A	7/64	2 1/4	57	1 3/8	35
SZ-10	SC-314	SZ-10-A	1/8	2 1/4	57	1 3/8	35
SZ-11	SC-314	SZ-11-A	5/32	2 1/4	57	1 3/8	35
SZ-12	SC-314	SZ-12-A	3/16	2 1/4	57	1 3/8	35
SZ-13	SC-314	SZ-13-A	7/32	2 1/4	57	1 3/8	35
SZ-14	SC-314	SZ-14-A	1/4	2 1/4	57	1 3/8	35
SZ-15	SC-314	SZ-15-A	5/16	2 1/4	57	1 3/8	35
SZ-16	SC-314	SZ-16-A	3/8	2 1/4	57	1 3/8	35
SZ-17	SC-314	SZ-17-A	1/2	2 1/4	57	1 3/8	35
SZ-18	SC-314	SZ-18-A	9/16	2 1/4	57	1 3/8	35
SZ-19	SC-314	SZ-19-A	5/8	2 1/4	57	1 3/8	35

1/2" Square Drive

Part Number		Hex Size	Overall Length		Length of Insert		
Adapter Only	Insert Only		In.	mm	In.	mm	
SZ-41	SC-514	SZ-11-A	5/32	2 1/2	64	1 3/8	35
SZ-20	SC-514	SZ-12-A	3/16	2 1/2	64	1 3/8	35
SZ-21	SC-514	SZ-13-A	7/32	2 1/2	64	1 3/8	35
SZ-22	SC-514	SZ-14-A	1/4	2 1/2	64	1 3/8	35
SZ-23	SC-514	SZ-15-A	5/16	2 1/2	64	1 3/8	35
SZ-24	SC-514	SZ-16-A	3/8	2 1/2	64	1 3/8	35
SZ-25	SC-514	SZ-17-A	1/2	2 1/2	64	1 3/8	35
SZ-42	SC-520	SZ-31-A	1/2	2 1/2	64	1 9/16	40
SZ-43	SC-514	SZ-18-A	9/16	2 1/2	64	1 3/8	35
SZ-44	SC-520	SZ-32-A	9/16	2 1/2	64	1 9/16	40
SZ-26	SC-514	SZ-19-A	5/8	2 1/2	64	1 3/8	35
SZ-27	RP-520	SZ-33-A	5/8	2 1/2	64	1 9/16	40

Adapters with an "SC" prefix feature a set screw for locking in the bit.
An "RP" prefix indicates adapters with a thru hole for a spring pin.

7/16" Hex Insert Bit Only

Part Number	Hex Size	Overall Length
		In. mm
SZ-11-A-3	5/32	3 76
SZ-12-A-2	3/16	2 51
SZ-12-A-3	3/16	3 76
SZ-12-A-6	3/16	6 152
SZ-13-A-3	7/32	3 76
SZ-14-A-3	1/4	3 76
SZ-14-A-4	1/4	4 102
SZ-15-A-2	5/16	2 51
SZ-15-A-3	5/16	3 76
SZ-15-A-4	5/16	4 102
SZ-16-A-3	3/8	3 76
SZ-16-A-4	3/8	4 102

Use 7/16" Hex Insert Bits with 7/16" Female Hex Square drive adapters, page 26. These bits feature a thru hole on the hex flat for use with a spring pin.

Socket Head Bits with Square Drive Adapters, SAE

3/4" Square Drive

Part Number		Hex Size	Overall Length		Length of Insert		Bit Length (A)		
Adapter Only	Insert Only		In.	mm	In.	mm	In.	mm	
SZ-30	SC-720	SZ-30-A	3/8	2 5/8	67	1 9/16	40	29/32	23
SZ-31	SC-720	SZ-31-A	1/2	2 5/8	67	1 9/16	40	29/32	23
SZ-32	SC-720	SZ-32-A	9/16	2 5/8	67	1 9/16	40	29/32	23
SZ-33	RP-720	SZ-33-A	5/8	2 5/8	67	1 9/16	40	29/32	23
SZ-34	RP-720	SZ-34-A	3/4	2 5/8	67	1 9/16	40	29/32	23
SZ-37	RP-728	SZ-37-A	3/4	3 1/8	79	2	51	1 1/8	29
SZ-35	SC-720	SZ-35-A	7/8	2 5/8	67	1 9/16	40	29/32	23
SZ-38	RP-728	SZ-38-A	7/8	3 1/8	79	2	51	1 1/8	29
SZ-36	RP-720	SZ-36-A	1	2 5/8	67	1 9/16	40	29/32	23

1" Square Drive

Part Number		Hex Size	Overall Length		Length of Insert		Bit Length (A)		
Adapter Only	Insert Only		In.	mm	In.	mm	In.	mm	
SZ-80	RP-820	SZ-31-A	1/2	3 1/16	78	1 9/16	40	29/32	23
SZ-85	RP-828	SZ-85-A	5/8	3 1/4	83	2	51	1 1/8	29
SZ-86	RP-820	SZ-34-A	3/4	3 1/32	77	1 9/16	40	29/32	23
SZ-87	RP-828	SZ-37-A	3/4	3 1/4	83	2	51	1 1/8	29
SZ-88	SC-820	SZ-35-A	7/8	3 1/16	78	1 9/16	40	29/32	23
SZ-89	RP-828	SZ-38-A	7/8	3 1/4	83	2	51	1 1/8	29
SZ-91	RP-828	SZ-39-A	1	3 1/4	83	2	51	1 1/8	29
SZ-101	RP-848	SZ-101-A	1 1/4	3 1/2	89	2 5/8	67	1 3/8	35

An "RP" prefix indicates adapters with a roll pin that is inserted through the bit.

Socket Head Bit & Adapter Sets, SAE

- APH38** 8 piece, 3/8" square drive:
1/8, 9/64, 5/32, 3/16, 7/32, 1/4, 5/16, 3/8
- APH56** 6 piece, 1/2" square drive:
1/4, 5/16, 3/8, 1/2, 9/16, 5/8

Socket Head Bit & Adapter Sets, Metric

- APH35M** 5 piece, 3/8" square drive:
4mm, 5mm, 6mm, 8mm, 10mm
- APH56M** 6 piece, 1/2" square drive:
6mm, 8mm, 10mm, 12mm, 14mm, 17mm

Socket Head Adapters & Inserts, Metric

3/8" Square Drive

Part Number		Hex Size	Overall Length		Length of Insert		Bit Length (A)		
Adapter Only	Insert Only		In.	mm	In.	mm	In.	mm	
SZ-3-7-4mm	SC-314	SZ-7-4mm	4mm	2 1/4	57	1 3/8	35	7/8	22
SZ-3-7-5mm	SC-314	SZ-7-5mm	5mm	2 1/4	57	1 3/8	35	7/8	22
SZ-3-7-6mm	SC-314	SZ-7-6mm	6mm	2 1/4	57	1 3/8	35	7/8	22
SZ-3-7-8mm	SC-314	SZ-7-8mm	8mm	2 1/4	57	1 3/8	35	7/8	22
SZ-3-7-10mm	SC-314	SZ-7-10mm	10mm	2 1/4	57	1 3/8	35	7/8	22

1/2" Square Drive

Part Number		Hex Size	Overall Length		Length of Insert		Bit Length (A)		
Adapter Only	Insert Only		In.	mm	In.	mm	In.	mm	
SZ-5-7-4mm	SC-514	SZ-7-4mm	4mm	2 1/2	63	1 3/8	35	7/8	22
SZ-5-7-5mm	SC-514	SZ-7-5mm	5mm	2 1/2	63	1 3/8	35	7/8	22
SZ-5-7-6mm	SC-514	SZ-7-6mm	6mm	2 1/2	63	1 3/8	35	7/8	22
SZ-5-7-8mm	SC-514	SZ-7-8mm	8mm	2 1/2	63	1 3/8	35	7/8	22
SZ-5-7-10mm	SC-514	SZ-7-10mm	10mm	2 1/2	63	1 3/8	35	7/8	22
SZ-5-7-12mm	SC-514	SZ-7-12mm	12mm	2 1/2	63	1 3/8	35	7/8	22
SZ-5-7-14mm	SC-514	SZ-7-14mm	14mm	2 1/2	63	1 3/8	35	15/16	24
SZ-5-10-14mm	RP-520	SZ-10-14mm	14mm	2 1/2	63	1 9/16	40	29/32	23
SZ-5-10-17mm	RP-520	SZ-10-17mm	17mm	2 1/2	63	1 9/16	40	29/32	23
SZ-5-10-19mm	RP-520	SZ-10-19mm	19mm	2 1/2	63	1 9/16	40	29/32	23

3/4" Square Drive

Part Number		Hex Size	Overall Length		Length of Insert		Bit Length (A)		
Adapter Only	Insert Only		In.	mm	In.	mm	In.	mm	
SZ-7-10-10mm	RP-720	SZ-10-10mm	10mm	2 1/2	64	1 9/16	40	29/32	23
SZ-7-10-12mm	RP-720	SZ-10-12mm	12mm	2 1/2	64	1 9/16	40	29/32	23
SZ-7-10-14mm	RP-720	SZ-10-14mm	14mm	2 1/2	64	1 9/16	40	29/32	23
SZ-7-10-17mm	RP-720	SZ-10-17mm	17mm	2 1/2	64	1 9/16	40	29/32	23

1" Square Drive

Part Number		Hex Size	Overall Length		Length of Insert		Bit Length (A)		
Adapter Only	Insert Only		In.	mm	In.	mm	In.	mm	
SZ-8-14-17mm	RP-828	SZ-14-17mm	17mm	3 5/16	84	2	51	1 1/8	29
SZ-8-14-19mm	RP-828	SZ-14-19mm	19mm	3 5/16	84	2	51	1 1/8	29
SZ-8-14-22mm	RP-828	SZ-14-22mm	22mm	3 5/16	84	2	51	1 1/8	29
SZ-8-14-24mm	RP-828	SZ-14-24mm	24mm	3 5/16	84	2	51	1 1/8	29
SZ-8-14-27mm	RP-828	SZ-14-27mm	27mm	3 5/16	84	2	51	1 1/8	29

BOLDED part numbers are industry popular items and are followed by common variations which may vary in price and availability.

Square Recess Bits

1/4" Hex Insert Bits

Part Number	Point Size	Nominal Size In.	Overall Length	
			In.	mm
950-0X	0	1/16	1	25
950-1X	1	3/32	1	25
950-2X	2	1/8	1	25
950-3X	3	9/64	1	25

1/4" Hex Power Drive

Part Number	Point Size	Nominal Size In.	Overall Length	
			In.	mm
954-0X	0	1/16	1 15/16	49
954-A-0X	0	1/16	2 3/4	70
954-C-0X	0	1/16	6	152
954-1X	1	3/32	1 15/16	49
954-A-1X	1	3/32	2 3/4	70
954-B-1X	1	3/32	3 1/2	89
954-C-1X	1	3/32	6	152
954-2X	2	1/8	1 15/16	49
954-A-2X	2	1/8	2 3/4	70
954-B-2X	2	1/8	3 1/2	89
954-C-2X	2	1/8	6	152
954-3X	3	9/64	1 15/16	49
954-A-3X	3	9/64	2 3/4	70
954-B-3X	3	9/64	3 1/2	89
954-C-3X	3	9/64	6	152

1/4" Hex Power Drive – Turned Body

Part Number	Point Size	Nominal Size In.	Overall Length		Turned Length	
			In.	mm	In.	mm
1950-0X	0	1/16	1 15/16	49	1 1/4	32
1951-0X	0	1/16	2 3/4	70	2	51
1950-1X	1	3/32	1 15/16	49	1 1/4	32
1951-1X	1	3/32	2 3/4	70	2	51
1953-1X	1	3/32	3 1/2	89	2 3/4	70
1950-2X	2	1/8	1 15/16	49	1 1/4	32
1951-2X	2	1/8	2 3/4	70	2	51
1953-2X	2	1/8	3 1/2	89	2 3/4	70
1950-3X	3	9/64	1 15/16	49	1 1/4	32
1951-3X	3	9/64	2 3/4	70	2	51
1953-3X	3	9/64	3 1/2	89	2 3/4	70

Screw Size	3 & 4	5, 6, 7	8, 9, 10	12-14 1/4
Square Point Size	0	1	2	3

Quad-rix bits available upon request.

BOLDED part numbers are industry popular items and are followed by common variations which may vary in price and availability.

Male Square Inserts for Pipe Plugs

1/4" to 1/2" Male Square

Part Number	Male Hex In.	Male Square In.	Overall Length	
			In.	mm
P-1408	7/16	1/4	1 1/4	32
P-1409	7/16	9/32	1 1/4	32
P-1410	7/16	5/16	1 1/4	32
P-1412	7/16	3/8	1 1/4	32
P-1414	7/16	7/16	1 1/4	32
P-1416	7/16	1/2	1 1/4	32
P-2010	5/8	5/16	1 1/2	38
P-2012	5/8	3/8	1 1/2	38
P-2014	5/8	7/16	1 1/2	38
P-2016	5/8	1/2	1 1/2	38

Note: For pipe plug inserts use SC and RP bit holders found on page 26.

Torq-Set® Bits

1/4" Hex Insert Bits

Part Number	Point Size	Overall Length	
		In.	mm
212-0	0	1	25
212-1	1	1	25
212-2	2	1	25
212-3	3	1	25
212-4	4	1	25
212-5	5	1	25
212-6	6	1	25
212-8	8	1	25
212-10	10	1	25
212-1/4	1/4	1	25

1/4" Hex Insert Bits – ACR® Available with ACR® ribs for removal only

Part Number	Point Size	Overall Length	
		In.	mm
212-6-ACR	6	1 1/4	32
212-8-ACR	8	1 1/4	32
212-10-ACR	10	1 1/4	32
212-1/4-ACR	1/4	1 1/4	32

5/16" Hex Insert Bits

Part Number	Point Size	Overall Length	
		In.	mm
212-8A	8	1 1/4	32
212-10A	10	1 1/4	32
212-1/4A	1/4	1 1/4	32
212-5/16A	5/16	1 1/4	32
212-3/8A	3/8	1 1/4	32

5/16" Hex Insert Bits – ACR® Available with ACR® ribs for removal only

Part Number	Point Size	Overall Length	
		In.	mm
212-1/4A-ACR	1/4	1 1/4	32
212-5/16A-ACR	5/16	1 1/4	32

BOLDED part numbers are industry popular items and are followed by common variations which may vary in price and availability.

Torq-Set® and ACR® are registered trademarks of the Phillips Screw Company.

1/4" Hex Power Drive

Part Number	Point Size	Overall Length	
		In.	mm
170-0	0	1 1/4	32
273-0	0	1 15/16	49
273B-0	0	2 3/4	70
265-0	0	3 1/2	89
265A-0	0	6	152
170-1	1	1 1/4	32
273A-1	1	1 13/16	46
273-1	1	1 15/16	49
273B-1	1	2 3/4	70
265-1	1	3 1/2	89
265A-1	1	6	152
170-2	2	1 1/4	32
273A-2	2	1 13/16	46
273-2	2	1 15/16	49
273B-2	2	2 3/4	70
265-2	2	3 1/2	89
265A-2	2	6	152
170-3	3	1 1/4	32
273A-3	3	1 13/16	46
273-3	3	1 15/16	49
273B-3	3	2 3/4	70
265-3	3	3 1/2	89
265A-3	3	6	152
170-4	4	1 1/4	32
273A-4	4	1 13/16	46
273-4	4	1 15/16	49
273B-4	4	2 3/4	70
265-4	4	3 1/2	89
265A-4	4	6	152
170-5	5	1 1/4	32
273-5	5	1 15/16	49
273B-5	5	2 3/4	70
265-5	5	3 1/2	89
265A-5	5	6	152
170-6	6	1 1/4	32
170-6-ACR*	6	1 1/4	32
273A-6	6	1 13/16	46
273-6	6	1 15/16	49
273B-6	6	2 3/4	70
265-6	6	3 1/2	89
265A-6	6	6	152
170-8	8	1 1/4	32
170-8-ACR*	8	1 1/4	32
273A-8	8	1 13/16	46
273-8	8	1 15/16	49
273B-8	8	2 3/4	70
265-8	8	3 1/2	89
265A-8	8	6	152
170-10	10	1 1/4	32
170-10-ACR*	10	1 1/4	32
273A-10	10	1 13/16	46
273-10	10	1 15/16	49
273B-10	10	2 3/4	70
265-10	10	3 1/2	89
265A-10	10	6	152
170-1/4B	1/4	1 1/4	32
170-5/16B	5/16	1 1/4	32
170-3/8B	3/8	1 1/4	32

*Feature ACR® anti-camout ribs.

Torq-Set® Bits



5/16" Hex Power Drive



Part Number	Point Size	Overall Length	
		In.	mm
170-8A	8	1 1/4	32
170-10A	10	1 1/4	32
170-1/4A	1/4	1 1/4	32
170-5/16A	5/16	1 1/4	32
170-3/8A	3/8	1 1/4	32

7/16" Hex Power Drive



Part Number	Point Size	Overall Length	
		In.	mm
170-1/4	1/4	1 1/4	32
265-1/4	1/4	3 1/2	89
265A-1/4	1/4	6	152
170-5/16	5/16	1 1/4	32
265-5/16	5/16	3 1/2	89
265A-5/16	5/16	6	152
170-3/8	3/8	1 1/4	32
170-3/8C	3/8	1 1/4	32
265A-3/8	3/8	6	152
170-7/16	7/16	1 1/4	32
170-7/16C	7/16	1 1/4	32
265A-7/16	7/16	6	152

7/16" Hex Power Drive – ACR®

Available with ACR® ribs for removal only



Part Number	Point Size	Overall Length	
		In.	mm
170-1/4-ACR	1/4	1 1/4	32
170-5/16-ACR	5/16	1 1/4	32

5/8" Hex Power Drive



Part Number	Point Size	Overall Length	
		In.	mm
170-1/2	1/4	1 1/4	32
170-9/16	9/16	1 1/4	32
170-5/8	5/8	1 1/4	32

BOLDED part numbers are industry popular items and are followed by common variations which may vary in price and availability.

Tri-Wing®



1/4" Hex Insert Bits



Part Number	Recess Size	Screw Size Tension Head	Screw Size Shear Head	Overall Length	
				In.	mm
TWD-0	0	0-80	-	1	25
TWD-1	1	2-56	4-40	1	25
TWD-2	2	4-40	6-32	1	25
TWD-3	3	6-32	8-32	1	25
TWD-4	4	8-32	10-32	1	25
TWD-5	5	10-32	1/4-28	1	25
TWD-6	6	1/4	5/16	1	25
TWD-7	7	5/16	3/8	1	25

1/4" Hex Insert Bits – ACR®

Available with ACR® ribs for removal only



Part Number	Recess Size	Screw Size Tension Head	Screw Size Shear Head	Overall Length	
				In.	mm
TWD-4-ACR	4	8-32	10-32	1	25
TWD-5-ACR	5	10-32	1/4-28	1	25

5/16" Hex Insert Bit



Part Number	Recess Size	Screw Size Tension Head	Screw Size Shear Head	Overall Length	
				In.	mm
TWE-4	4	8-32	10-32	1 1/4	32
TWE-5	5	10-32	1/4-28	1 1/4	32

1/4" Hex Power Drive



Part Number	Recess Size	Screw Size Tension Head	Screw Size Shear Head	Overall Length	
				In.	mm
TW-0	0	0-80	-	1 1/4	32
TW-1	1	2-56	4-40	1 1/4	32
TW-2	2	4-40	6-32	1 1/4	32
TW-3	3	6-32	8-32	1 1/4	32
TW-4	4	8-32	10-32	1 1/4	32
TW-5	5	10-32	1/4-28	1 1/4	32
TWB-6	6	1/4-28	5/16-24	1 1/4	32
TWB-7	7	5/16-24	3/8-24	1 1/4	32
TWB-8	8	3/8-24	7/16-20	1 1/4	32

5/16" Hex Power Drive



Part Number	Recess Size	Screw Size Tension Head	Screw Size Shear Head	Overall Length	
				In.	mm
TWA-6	6	1/4-28	5/16-24	1 1/4	32
TWA-7	7	5/16-24	3/8-24	1 1/4	32
TWA-8	8	3/8-24	7/16-20	1 1/4	32

7/16" Hex Power Drive



Part Number	Recess Size	Screw Size Tension Head	Screw Size Shear Head	Overall Length	
				In.	mm
TW-6	6	1/4-28	5/16-24	1 1/4	32
TW-7	7	5/16-24	3/8-24	1 1/4	32

3/4" Hex Power Drive



Part Number	Recess Size	Screw Size Tension Head	Screw Size Shear Head	Overall Length	
				In.	mm
TW-14	14	7/8-14	1-12	3	76
TW-15	15	1-12	-	3	76

Torq-Set®, ACR® and Tri-Wing® are registered trademarks of the Phillips Screw Company.

Hi-Torque® Bits



1/4" Square Drive Insert Bits



Part Number	Recess	Overall Length In.	Body Diameter In.	Blade	Blade
				Thickness In.	Width In.
HTS-0	0	1	1/2	.029	.167
HTS-1	1	1	1/2	.049	.274
HTS-2	2	1	1/2	.059	.295
HTS-3	3	1	1/2	.059	.377
HTS-4	4	1	1/2	.073	.502

3/8" Square Drive Insert Bits



Part Number	Recess	Overall Length In.	Body Diameter In.	Blade	Blade
				Thickness In.	Width In.
HTS-3A	3	1	3/4	.059	.377
HTS-4A	4	1	3/4	.073	.502
HTS-5	5	1 1/4	3/4	.079	.629
HTS-6	6	1 1/4	3/4	.095	.745

1/2" Square Drive Insert Bits



Part Number	Recess	Overall Length In.	Body Diameter In.	Blade	Blade
				Thickness In.	Width In.
HTS-7	7	1 5/8	1	.112	.884
HTS-8	8	1 5/8	1	.142	.995
HTS-9	9	1 5/8	1 1/4	.162	1.136
HTS-10	10	1 5/8	1 1/4	.182	1.250
HTS-12	12	2 3/8	1 1/4	.216	1.500

1/4" Hex Insert Bits



Part Number	Recess	Overall Length In.	Body Diameter In.	Blade	Blade
				Thickness In.	Width In.
HTN-B-1	1	1 1/4	9/32	.049	.274
HTN-B-2	2	1 1/4	5/16	.059	.295
HTN-B-3	3	1 1/4	3/8	.059	.377
HTN-B-4	4	1 1/4	1/2	.073	.502

Nominal Screw Size 0 1 2 3 4 5 6 8 10 1/4 5/16 3/8 7/16 1/2 9/16 5/8 3/4

Hi-Torque Recess 0 0 0 1 1 1 1 2 3 4 5 6 7 8 9 10 12

BOLDED part numbers are industry popular items and are followed by common variations which may vary in price and availability.

Hi-Torque®—Rudy Vaughn, Licensor

Triple Square Bits



1/4" Hex Insert Bits



Part Number	Point Size	Overall Length	
		In.	mm
440-TSQ-4M	4mm	1	25
440-TSQ-5M	5mm	1	25
440-TSQ-6M	6mm	1	25
440-TSQ-8M	8mm	1	25
440-TSQ-10M	10mm	1	25

5/16" Hex Insert Bits



Part Number	Point Size	Overall Length	
		In.	mm
480-TSQ-6M	6mm	1 1/4	32
480-TSQ-8M	8mm	1 1/4	32
480-TSQ-10M	10mm	1 1/4	32
480-TSQ-12M	12mm	1 1/4	32
480-TSQ-14M	14mm	1 1/4	32

1/4" Hex Power Drive



Part Number	Point Size	Overall Length	
		In.	mm
49-TSQ-4M	4mm	2	50
49-TSQ-5M	5mm	2	50
49-TSQ-6M	6mm	2	50
49-TSQ-8M	8mm	2	50
49-TSQ-10M	10mm	2	50
49-TSQ-12M	12mm	2	50

7/16" Hex Power Drive



Part Number	Point Size	Overall Length	
		In.	mm
48-TSQ-5M	5mm	3 1/2	88
48-TSQ-6M	6mm	3 1/2	88
48-TSQ-8M	8mm	3 1/2	88
48-TSQ-10M	10mm	3 1/2	88
48-TSQ-12M	12mm	3 1/2	88
48-TSQ-14M	14mm	3 1/2	88

Does Apex offer magnetic bit holders?

Bit holders, like this Apex M-490, let you use a variety of insert bits in power tool applications. You get economy and flexibility – and fasteners can be magnetically held to the bit.

(See page 48)



Do Apex quick-release bit holders hold bits securely?

A quick-release bit holder allows fast, easy insert bit changes while assuring that bits stay securely in the bit holder. Simply pull back on the knurled sleeve to release the bit.

(See pages 48)



If the tool you need does not appear in this catalog, give us a call. The odds are, we may have what you need as a non-catalog item. If not, our experienced staff of tooling experts can design and manufacture "specials" to meet the needs of your specific application. Give us a call at 1-800-845-5629 or visit our website www.apex-tools.com.

Does Apex offer quick release chucks?

Apex has a complete line of quick release chucks that provide fast and easy power bit changes.

(See page 49)



Bit Holders

1/4" Hex Drive for 1/4" Hex Inserts

Part Number	Overall Length	
	In.	mm
490	2 1/8	54
490-3	3	76
490-4	4	102
490-5	5	127
490-6	6	152
490-8	8	203
490-10	10	254

M-490-2	2	51	Magnetic
M-490-NR	2 31/32	75	Magnetic; No lock ring
M-490	2 31/32	75	Magnetic
M-497	3 3/32	79	Magnetic; 3/8" (9.5mm) reduced dia.
M-490-4	4	102	Magnetic
M-490-6	6	152	Magnetic
M-490-8	8	203	Magnetic
M-490-10	10	254	Magnetic
M-490-12	12	304	Magnetic
M-44-90	3 1/4	83	Magnetic; for Flip-Tip™ reversible bits

M-495	2 7/8	73	Magnetic; 3/8" (9.5mm) turned shank
M-495-5	5	127	Magnetic; 3/8" (9.5mm) turned shank

RM-490	2 7/8	73	Magnetic; nose piece only, #490-RN
RM-490-4	4	102	Magnetic; nose piece only, #490-RN
RM-490-6	6	152	Magnetic; nose piece only, #490-RN

M-490-2-OR	2	51	Magnetic; with O-Ring retainer
M-490-OR	3	76	Magnetic; with O-Ring retainer

1/4" Hex Drive for 1/4" Hex Inserts, Quick Release

Part Number	Overall Length		
	In.	mm	
QR-M-490-2	2	51	Magnetic; quick release
QR-M-490-A	2 29/32	74	Magnetic; quick release
QR-M-490-A6	6	152	Magnetic; quick release
QR-M-490-200M	7 7/8	200	Magnetic; quick release

1/4" Hex Drive for 5/16" Hex Inserts

Part Number	Overall Length		
	In.	mm	
498	2 3/8	60	
M-498	3 1/16	78	Magnetic

5/16" Hex Drive

Part Number	Overall Length		
	In.	mm	
630	1 13/16	46	For 1/4" hex inserts
M-630	3	76	For 1/4" hex inserts; magnetic
638	2 1/2	64	For 5/16" hex inserts
M-638	3 3/32	79	For 5/16" hex inserts; magnetic

5/16" Buckeye-Desoutter for 1/4" Hex Inserts

Part Number	Overall Length		
	In.	mm	
610	2	51	
M-610	3 3/16	81	Magnetic

7/16" Hex Drive

Part Number	Overall Length		
	In.	mm	
488	2 3/4	70	For 1/4" hex inserts
M-488	3 1/16	78	For 1/4" hex inserts; magnetic
480	2 3/4	70	For 5/16" hex inserts
M-480	3 5/16	84	For 5/16" hex inserts; magnetic
M-480-6	6	152	For 5/16" hex inserts; magnetic

9/32" 130-A Yankee Type for 1/4" Hex Inserts

Part Number	Overall Length		
	In.	mm	
450	2 1/4	57	
M-450	3 3/8	86	Magnetic

5/16" 131-A Yankee Type for 1/4" Hex Inserts

Part Number	Overall Length		
	In.	mm	
460	2 1/4	57	
M-460	3 3/8	86	Magnetic

7/32" 135-A Yankee Type for 1/4" Hex Inserts

Part Number	Overall Length		
	In.	mm	
M-470	3 3/8	86	Magnetic

1/4"-24 Screw Shank for 1/4" Hex Inserts

Part Number	Overall Length		
	In.	mm	
400-BH	1 1/8	29	

BOLDED part numbers are industry popular items and are followed by common variations which may vary in price and availability.

Bit Holders

1/4" Female Square Drive



Part Number	Overall Length		
	In.	mm	
825	1	25	For 1/4" hex inserts
M-825	2 9/32	58	For 1/4" hex inserts; magnetic
820	23/32	18	For 1/4" square inserts

3/8" Female Square Drive



Part Number	Overall Length		
	In.	mm	
838	1 1/2	38	For 1/4" hex inserts
M-838	2 23/32	69	For 1/4" hex inserts; magnetic
835	1 1/2	38	For 5/16" hex inserts
M-835	2 3/4	70	For 5/16" hex inserts; magnetic
830	1 1/2	38	For 5/16" square inserts

1/2" Female Square Drive



Part Number	Overall Length		
	In.	mm	
858	1 3/4	45	For 1/4" hex inserts
M-858	2 3/4	70	For 1/4" hex inserts; magnetic
855	1 3/4	45	For 5/16" hex inserts
M-855	2 3/4	70	For 5/16" hex inserts; magnetic
850	1 3/4	45	For 5/16" square inserts

Bit Holders/Adapters with Set Screw or Thru Hole

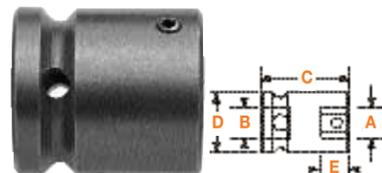

Set Screw Lock	Hex Opening (A)		Square Drive (B)		Overall Length (C)		Body Diameter (D)		Opening Depth (E)	
	In.	mm	In.	mm	In.	mm	In.	mm	In.	mm
SC-108	1/4	1/4	1 1/4	32	3/4	19	5/8	16		
SC-308	1/4	3/8	1 1/2	38	3/4	19	5/8	16		
SC-508	1/4	1/2	1 1/2	38	7/8	22	5/8	16		
SC-114	7/16	1/4	1	25	3/4	19	17/32	13		
SC-314	7/16	3/8	1 3/8	35	3/4	19	17/32	13		
SC-514	7/16	1/2	1 5/8	41	15/16	24	17/32	13		
SC-614	7/16	5/8	1 3/4	46	1 1/4	32	17/32	13		
SC-520	5/8	1/2	1 1/2	38	1 1/8	29	11/16	17		
SC-620	5/8	5/8	1 1/2	38	1 1/4	32	11/16	17		
SC-720	5/8	3/4	1 11/16	43	1 1/2	38	11/16	17		
SC-820	5/8	1	2 1/8	54	2 1/8	54	11/16	17		
SC-724	3/4	3/4	2	51	1 5/8	42	7/8	22		
SC-728	7/8	3/4	2	51	1 5/8	42	57/64	23		
SC-828	7/8	1	2 1/8	54	2 1/8	54	5/8	23		

Note: Use SC bit holders with socket head inserts (page 19) and pipe plug inserts (page 21). Can be used with power bits.

Female Threaded Drive, Quick Releasing Chucks



Part Number	Female Thread		Hex Opening		Overall Length		Overall Diameter		Opening Depth	
	In.	mm	In.	mm	In.	mm	In.	mm	In.	mm
QRA-08	3/8"-24	1/4	1 3/4	45	3/4	19	61/64	24		
QRA-14	3/8"-24	7/16	2	51	1 1/4	32	1 1/16	27		
QRF-08	1/2"-20	1/4	1 3/4	45	3/4	19	61/64	24		
QRF-14	1/2"-20	7/16	2	51	1 1/4	32	1 1/16	27		
QRF-20	1/2"-20	5/8	2 5/8	67	1 5/8	41	1 1/2	38		

Female Square Drive, Quick Releasing Chucks

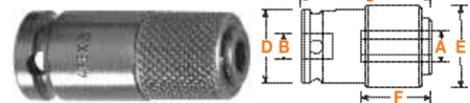

Part Number	Hex Square Open. Drive (A) (B)		Overall Length (C)		Body Diameter (D)		Sleeve Diameter (E)		Opening Depth (F)	
	In.	mm	In.	mm	In.	mm	In.	mm	In.	mm
QR-108	1/4	1/4	1 1/2	38	3/4	19	3/4	19	61/64	24
QR-308	1/4	3/8	1 3/4	45	3/4	19	3/4	19	61/64	24
QR-508	1/4	1/2	2 1/8	54	7/8	22	3/4	19	61/64	24
QR-314	7/16	3/8	2	51	1	25	1 1/4	32	1 3/32	28
QR-514	7/16	1/2	2 1/8	54	1	25	1 1/4	32	1 1/16	27
QR-614	7/16	5/8	2 1/8	54	1 1/4	32	1 1/4	32	1 1/16	27
QR-714	7/16	3/4	2 3/8	60	1 1/2	38	1 1/4	32	1 1/16	27
QR-520	5/8	1/2	2 5/8	67	1 1/2	38	1 5/8	41	1 1/2	38
QR-620	5/8	5/8	2 5/8	67	1 1/2	38	1 5/8	41	1 1/2	38
QR-720	5/8	3/4	3 1/8	79	1 1/2	38	1 5/8	41	1 1/2	38
QR-820	5/8	1	3 1/4	83	2 1/8	54	1 5/8	41	1 1/2	38
QR-824	3/4	1	3 3/4	95	2	51	1 7/8	48	1 5/8	41

1/4" Hex Drive Nutsetters for Sheet Metal Screws

6 Point Power Drive, SAE



Part Number	Size	Overall Length		Socket Nose Diameter		
		In.	mm	In.	mm	
DB-08	1/4	2 9/16	7/16	Non-magnetic		
DB-10	5/16	2 9/16	1/2	Non-magnetic		
DB-12	3/8	2 9/16	9/16	Non-magnetic		
MDA-08	1/4	1 3/4	7/16	Magnetic		
MDAT-08	1/4	1 3/4	3/8	Magnetic		
MDA-10	5/16	1 3/4	1/2	Magnetic		
MDA-12	3/8	1 3/4	9/16	Magnetic		
MDA-14	7/16	2	11/16	Magnetic		
MDB-08	1/4	2 9/16	7/16	Magnetic	5/16" Shank Diameter	
MDB-10	5/16	2 9/16	1/2	Magnetic	5/16" Shank Diameter	
MDB-12	3/8	2 9/16	9/16	Magnetic	5/16" Shank Diameter	
MDB-14	7/16	2 9/16	5/8	Magnetic	5/16" Shank Diameter	
MDC-08	1/4	2 9/16	7/16	Magnetic	3/8" Shank Diameter	
MDC-10	5/16	2 9/16	1/2	Magnetic	3/8" Shank Diameter	
MDC-12	3/8	2 9/16	9/16	Magnetic	3/8" Shank Diameter	

6 Point Insert, SAE



Part Number	Size	Overall Length		Socket Nose Diameter		
		In.	mm	In.	mm	
MHM-1310	5/16	1 1/8	1/2	Magnetic		
MHM-1912	3/8	1 3/4	9/16	Magnetic		

6 Point Power Drive, Metric



Part Number	Size	Overall Length		Socket Nose Diameter		
		mm	mm	mm	mm	
MDA-6mm	6	44.5	9.5	Magnetic		
MDA-7mm	7	44.5	11.1	Magnetic		
MDA-8mm	8	44.5	12.7	Magnetic		
MDA-10mm	10	44.5	14.3	Magnetic		
MDA-10mm-80m	10	80.0	14.3	Magnetic		

6 Point Insert, Metric



Part Number	Size	Overall Length		Socket Nose Diameter		
		mm	mm	mm	mm	
MHM-7mm	7	31.8	11.1	Magnetic		
MHM-8mm	8	31.8	12.7	Magnetic		
MHM-10mm	10	31.8	14.3	Magnetic		

1/4" Hex Drive Nutsetters

APEX

6 Point and 6 Point Magnetic, SAE



Part Number	Part Number	Size	Overall Length		Socket Nose Diameter
			In.	mm	
6N-0806-2	M6N-0806-2	3/16	2	5/16	
6N-0806-3	M6N-0806-3	3/16	3	5/16	
-	M6N-0806-5	3/16	5	5/16	
-	M6N-0806-6	3/16	6	5/16	
6N-0808-2	M6N-0808-2	1/4	2	7/16	
6N-0808-3	M6N-0808-3	1/4	3	7/16	
6N-0808-4	M6N-0808-4	1/4	4	7/16	
6N-0808-5	M6N-0808-5	1/4	5	7/16	
6N-0808-6	M6N-0808-6	1/4	6	7/16	
6N-0810-2	M6N-0810-2	5/16	2	1/2	
6N-0810-3	M6N-0810-3	5/16	3	1/2	
6N-0810-4	M6N-0810-4	5/16	4	1/2	
6N-0810-5	M6N-0810-5	5/16	5	1/2	
6N-0810-6	M6N-0810-6	5/16	6	1/2	
6N-0811-2	M6N-0811-2	11/32	2	9/16	
6N-0811-3	M6N-0811-3	11/32	3	9/16	
6N-0812-2	M6N-0812-2	3/8	2	9/16	
6N-0812-3	M6N-0812-3	3/8	3	9/16	
6N-0812-4	M6N-0812-4	3/8	4	9/16	
6N-0812-6	M6N-0812-6	3/8	6	9/16	
6N-0814-2	M6N-0814-2	7/16	2	21/32	
6N-0814-3	M6N-0814-3	7/16	3	21/32	
6N-0814-4	M6N-0814-4	7/16	4	21/32	
6N-0814-6	M6N-0814-6	7/16	6	21/32	
6N-0816-2	M6N-0816-2	1/2	2	3/4	
6N-0816-3	M6N-0816-3	1/2	3	3/4	
6N-0818-2	M6N-0818-2	9/16	2	13/16	

6 Point and 6 Point Magnetic, Metric



Part Number	Part Number	Size	Overall Length		Socket Nose Diameter
			mm	mm	
6N-08-8M-3	M6N-08-8M-3	8	76	12.7	
6N-08-8M-4	M6N-08-8M-4	8	102	12.7	
6N-08-8M-6	M6N-08-8M-6	8	152	12.7	
6N-08-10M-3	M6N-08-10M-3	10	76	14.3	
6N-08-10M-4	M6N-08-10M-4	10	102	14.3	
6N-08-10M-6	M6N-08-10M-6	10	76	14.3	
6N-08-12M-3	M6N-08-12M-3	12	76	19.0	
6N-08-12M-4	M6N-08-12M-4	12	102	19.0	
6N-08-12M-6	M6N-08-12M-6	12	152	19.0	

1/4" Hex Drive Nutsetters

6 Point, Bolt Clearance



Part Number	Size	Overall Length	Socket Nose Diameter	Depth of Clearance (A)
6 Point	In.	In.	In.	In.
6B-0808	1/4	3 1/4	7/16	1 3/8
6B-0809	9/32	3 1/4	1/2	1 3/8
6B-0810	5/16	3 1/4	1/2	1 3/8
6B-0811	11/32	3 1/4	9/16	1 3/8
6B-0812	3/8	3 1/4	9/16	1 3/8
6B-0814	7/16	3 1/4	21/32	1 3/8
6B-0816	1/2	3 1/4	3/4	1 3/8
6B-0818	9/16	3 1/4	13/16	1 3/8
6B-0820	5/8	3 1/4	7/8	1 3/8

See bolt clearance Tool Tip page 32.

7/16" Hex Drive Nutsetters

6 Point



Part Number	Size	Overall Length	Socket Nose Diameter
6 Point	In.	In.	In.
6N-1410-3	5/16	3	9/16
6N-1412-3	3/8	3	9/16
6N-1414-3	7/16	3	3/4
6N-1416-3	1/2	3	13/16
6N-1416-4	1/2	4	13/16
6N-1418-3	9/16	3	7/8
6N-1418-6	9/16	6	7/8
6N-1420-3	5/8	3	1
6N-1424-3	3/4	3	1 1/8
6N-1424-6	3/4	6	1 1/8

5/8" Hex Drive Nutsetters

6 Point



Part Number	Size	Overall Length	Socket Nose Diameter
6 Point	In.	In.	In.
6N-2028-4	7/8	4	1 3/8
6N-2036-4	1 1/8	4	1 5/8

Hand Drivers

Drivers with Self-Contained Insert Bits



Part No.	Female Hex Size	Overall Length	Blade Projection	Phillips #1, #2, #3; Slotted 4F-5R, 10F-12R; hollow handle.
	In.	In.	In.	
M-15-SC	1/4	8 1/2	216 4 3/8 111	Phillips #1, #2, #3; Slotted 4F-5R, 10F-12R; hollow handle.
M-15-SC-A	1/4	8 1/2	216 4 3/8 111	Without bits; hollow handle.

Replaceable Bit Drivers



Part No.	Female Hex Size	Overall Length	Blade Projection
	In.	In.	In.
1510-P	1/4	2 3/4	70 7/8 22
1500-P	1/4	7 1/2	191 3 9/32 83

Replaceable Bit Drivers – Magnetic



Part No.	Female Hex Size	Overall Length	Blade Projection
	In.	In.	In.
M-1505-P	1/4	2 3/8	60 3/8 10
M-1500-P	1/4	8 1/2	216 4 3/8 111



24 Bit Kit

Industrial Bit Kit

Tool kit includes plastic carrying case with: Magnetic hand driver and magnetic bit holder.
 Phillips bits: #1, #2, #3
 Slotted bits: 3F-4R, 4F-5R, 6F-8R, 8F-10R, 10F-12R
 Torx® bits: T-10, T-15, T-20, T-25, T-27, T-30, T-40
 Square Recess bits: 3/32", 1/8"
 Hex bits: 5/64", 3/32", 7/64", 1/8", 9/64"
 Pozidriv® bits: #1, #2

Awls



Part Number	Overall Length	Shank Diameter
	In. mm	In. mm
AW-95	7 7/16 189	.307 7.8
AW-95-L	8 203	.307 7.8
AW-95-LL	8 7/8 225	.307 7.8

Use awls to line up hole and scratch mark surfaces.

Hex Extensions

Male Hex Drive with 1/4" Male Square



Part Number	Hex Drive	Type of Lock	Overall Length
	In.		In. mm
EX-250	1/4	Pin	1 3/8 35
EX-250-B	1/4	Ball	1 3/8 35
EX-250-2	1/4	Pin	2 51
EX-250-B-2	1/4	Ball	2 51
EX-250-3	1/4	Pin	3 76
EX-250-B-3	1/4	Ball	3 76
EX-250-4	1/4	Pin	4 102
EX-250-B-4	1/4	Ball	4 102
EX-250-5	1/4	Pin	5 127
EX-250-B-5	1/4	Ball	5 127
EX-250-6	1/4	Pin	6 152
EX-250-B-6	1/4	Ball	6 152
EX-250-8	1/4	Pin	8 203
EX-250-B-8	1/4	Ball	8 203
EX-250-12	1/4	Pin	12 305
EX-250-B-12	1/4	Ball	12 305
EX-262	5/16	Pin	1 1/2 38
EX-262-4	5/16	Pin	4 102
EX-262-B-4	5/16	Ball	4 102
EX-262-6	5/16	Pin	6 152
EX-251	7/16	Pin	1 3/8 35
EX-251-B	7/16	Ball	1 3/8 35
EX-251-2	7/16	Pin	2 51
EX-251-B-2	7/16	Ball	2 51
EX-251-3	7/16	Pin	3 76
EX-251-6	7/16	Pin	6 152
EX-251-8	7/16	Pin	8 203
EX-251-10	7/16	Pin	10 254

Male Hex Drive with 3/8" Male Square



Part Number	Hex Drive	Type of Lock	Overall Length
	In.		In. mm
EX-250	1/4	Pin	1 3/8 35
EX-370	1/4	Pin	1 5/8 41
EX-370-B	1/4	Ball	1 5/8 41
EX-370-2	1/4	Pin	2 51
EX-370-B-2	1/4	Ball	2 51
EX-370-3	1/4	Pin	3 76
EX-370-B-3	1/4	Ball	3 76
EX-370-4	1/4	Pin	4 102
EX-370-B-4	1/4	Ball	4 102
EX-370-5	1/4	Pin	5 127
EX-370-6	1/4	Pin	6 152
EX-370-B-6	1/4	Ball	6 152
EX-370-8	1/4	Pin	8 203
EX-370-B-8	1/4	Ball	8 203
EX-370-10	1/4	Pin	10 254
EX-370-B-10	1/4	Ball	10 254
EX-380	5/16	Pin	1 1/2 38
EX-380-B	5/16	Ball	1 1/2 38
EX-380-2	5/16	Pin	2 51
EX-380-B-2	5/16	Ball	2 51
EX-380-3	5/16	Pin	3 76
EX-380-4	5/16	Pin	4 102
EX-380-6	5/16	Pin	6 152
EX-371	7/16	Pin	1 3/4 45
EX-371-2	7/16	Pin	2 51
EX-371-2 3/4	7/16	Pin	2 3/4 70
EX-371-3	7/16	Pin	3 76
EX-371-B-3	7/16	Ball	3 76
EX-371-4	7/16	Pin	4 102
EX-371-5	7/16	Pin	5 127
EX-371-6	7/16	Pin	6 152
EX-371-8	7/16	Pin	8 203
EX-371-10	7/16	Pin	10 254
EX-371-12	7/16	Pin	12 305
EX-371-15	7/16	Pin	15 381

BOLDED part numbers are industry popular items and are followed by common variations which may vary in price and availability.

BOLDED part numbers are industry popular items and are followed by common variations which may vary in price and availability.

Hex Extensions

Male Hex Drive with 1/2" Male Square



Part Number	Hex Drive In.	Type of Lock	Overall Length In.	Overall Length mm
EX-500-2	1/4	Pin	2	51
EX-500-B-2	1/4	Ball	2	51
EX-500-3	1/4	Pin	3	76
EX-500-B-3	1/4	Ball	3	76
EX-500-4	1/4	Pin	4	102
EX-500B-4	1/4	Ball	4	102
EX-500-6	1/4	Pin	6	152
EX-500-B-6	1/4	Ball	6	152
EX-512-2	5/16	Pin	2	51
EX-512-B-2	5/16	Ball	2	51
EX-512-3	5/16	Pin	3	76
EX-512-B-4	5/16	Ball	4	102
EX-501-2	7/16	Pin	2 1/8	54
EX-501-B-2	7/16	Ball	2 1/8	54
EX-501-3	7/16	Pin	3	76
EX-501-B-3	7/16	Ball	3	76
EX-501-4	7/16	Pin	4	102
EX-501-B-4	7/16	Ball	4	102
EX-501-5	7/16	Pin	5	127
EX-501-B-5	7/16	Ball	5	127
EX-501-6	7/16	Pin	6	152
EX-501-B-6	7/16	Ball	6	152
EX-501-8	7/16	Pin	8	203
EX-501-B-8	7/16	Ball	8	203
EX-501-10	7/16	Pin	10	254
EX-501-B-10	7/16	Ball	10	254
EX-501-12	7/16	Pin	12	305
EX-501-B-12	7/16	Ball	12	305
EX-501-15	7/16	Pin	15	381
EX-502	5/8	Pin	2	51
EX-502-B	5/8	Ball	2	51
EX-502-3	5/8	Pin	3	76
EX-502-B-3	5/8	Ball	3	76
EX-502-B-4	5/8	Ball	4	102
EX-502-5	5/8	Pin	5	127
EX-502-6	5/8	Pin	6	152
EX-502-8	5/8	Pin	8	203

Male Hex Drive with 5/8" Male Square



Part Number	Hex Drive In.	Type of Lock	Overall Length In.	Overall Length mm
EX-620-3	7/16	Pin	3	76
EX-620-6	7/16	Pin	6	152
EX-621-3	5/8	Pin	3	76
EX-621-B-3	5/8	Ball	3	76
EX-621-6	5/8	Pin	6	152
EX-621-8	5/8	Pin	8	203

BOLDED part numbers are industry popular items and are followed by common variations which may vary in price and availability.

Male Hex Drive with 3/4" Male Square



Part Number	Hex Drive In.	Type of Lock	Overall Length In.	Overall Length mm
EX-757-3	7/16	7/32 Drill Hole	3	76
EX-757-B-3	7/16	Ball	3	76
EX-758-4	5/8	7/32 Drill Hole	4	102
EX-758-B-4	5/8	Ball	4	102
EX-758-6	5/8	7/32 Drill Hole	6	152
EX-758-9	5/8	7/32 Drill Hole	9	229

Extensions

Threaded Screw Shank



Part Number	Male Square In.	Male Thread In.	Overall Length In.	Overall Length mm	Body Diameter In.	Body Diameter mm
TH-256	1/4	1/4-28	1 5/8	41	7/16	11
TH-376	3/8	1/4-28	1 5/8	41	1/2	13
TH-250	1/4	1/4-24	1 5/8	41	7/16	11
TH-370	3/8	1/4-24	1 3/4	45	1/2	13
TH-372	3/8	1/4-20	1 3/4	45	1/2	13

1/4" Male Hex Universal Wrenches

SAE 6 Point, Standard & Tension Type - Extension

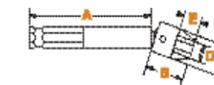

Standard Type		Tension Type					
Part Number Standard	Part Number Tension	Hex Opening In.	Shank Length (A) In.	Socket Length (B) In.	Socket Diameter (C) In.	Nose End Diameter (D) In.	Clearance Depth (E) In.
KC-25-3	-	1/4	3	3/4	5/8	3/8	3/8
KC-25-4	-	1/4	4	3/4	5/8	3/8	3/8
KC-25-6	KS-25-6	1/4	6	3/4	5/8	3/8	3/8
KC-25-9	-	1/4	9	3/4	5/8	3/8	3/8
KC-25-12	-	1/4	12	3/4	5/8	3/8	3/8
KC-26-3	-	5/16	3	3/4	5/8	7/16	3/8
KC-26-6	KS-26-6	5/16	6	3/4	5/8	7/16	3/8
KC-26-9	-	5/16	9	3/4	5/8	7/16	3/8
KC-26-12	KS-26-12	5/16	12	3/4	5/8	7/16	3/8
-	KS-100-6	5/16	6	3/4	3/4	7/16	5/16
KC-27-3	-	11/32	3	3/4	5/8	1/2	3/8
KC-27-6	-	11/32	6	3/4	5/8	1/2	3/8
KC-101-6	-	11/32	6	3/4	3/4	15/32	5/16
KC-28-3	-	3/8	3	13/16	5/8	9/16	7/16
KC-28-6	KS-28-6	3/8	6	13/16	5/8	9/16	7/16
-	KS-28-12	3/8	12	13/16	5/8	9/16	7/16
-	KS-102-6	3/8	6	13/16	3/4	9/16	3/8
KC-29-3	-	7/16	3	7/8	5/8	5/8	1/2
KC-29-6	KS-29-6	7/16	6	7/8	5/8	5/8	1/2
KC-30-3	-	1/2	3	7/8	11/16	11/16	1/2
KC-30-4	-	1/2	4	7/8	11/16	11/16	1/2
KC-30-6	KS-30-6	1/2	6	7/8	11/16	11/16	1/2
KC-30-9	-	1/2	9	7/8	11/16	11/16	1/2
-	KS-104-6	1/2	6	1	3/4	3/4	9/16
KC-105-6	KS-105-6	9/16	6	1	13/16	13/16	9/16
-	KS-105-9	9/16	9	1	13/16	13/16	9/16

Metric 6 Point, Standard & Tension Type - Extension

Part Number Standard	Part Number Tension	Hex Opening mm	Shank Length (A) mm	Socket Length (B) mm	Socket Diameter (C) mm	Nose End Diameter (D) mm	Clearance Depth (E) mm
KC-5-7m-4	-	7	102	19.1	15.9	10.3	9.5
KC-5-7m-6	KS-5-7m-6	7	152	19.1	15.9	10.3	9.5
-	KS-5-7m-9	7	229	19.1	15.9	10.3	9.5
KC-6-8m-3	-	8	76	19.1	19.1	11.1	7.9
KC-6-8m-4	-	8	102	19.1	19.1	11.1	7.9
KC-6-8m-6	KS-6-8m-6	8	152	19.1	19.1	11.1	7.9
-	KS-6-8m-9	8	229	19.1	19.1	11.1	7.9
KC-6-9m-6	-	9	152	19.1	19.1	12.7	7.9
KC-6-10m-3	-	10	76	20.6	19.1	15.1	9.5
KC-6-10m-4	-	10	102	20.6	19.1	15.1	9.5
KC-6-10m-6	KS-6-10m-6	10	152	20.6	19.1	15.1	9.5
KC-6-10m-9	KS-6-10m-9	10	229	20.6	19.1	15.1	9.5
KC-6-10m-12	-	10	305	20.6	19.1	15.1	9.5
KC-7-11m-6	KS-7-11m-6	11	152	23.8	22.2	15.9	10.3
KC-7-12m-3	-	12	76	23.8	22.2	17.5	10.3
KC-7-12m-6	-	12	152	23.8	22.2	17.5	10.3
KC-7-12m-9	-	12	229	23.8	22.2	17.5	10.3
KC-7-13m-3	-	13	76	25.4	22.2	17.5	11.9
KC-7-13m-6	KS-7-13m-6	13	152	25.4	22.2	17.5	11.9
KC-7-13m-9	KS-7-13m-9	13	229	25.4	22.2	17.5	11.9

Actual design of universal wrenches may not be exactly like pictures above.

Universal wrenches must not be used with impact drivers. Maximum operating angle is 30°.

BOLDED part numbers are industry popular items and are followed by common variations which may vary in price and availability.

7/16" Male Hex Universal Wrenches



SAE 6 Point, Standard & Tension Type - Extension

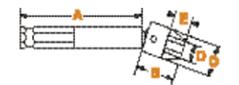

Standard Type		Tension Type					
Part Number Standard	Part Number Tension	Hex Opening In.	Shank Length (A) In.	Socket Length (B) In.	Socket Diameter (C) In.	Nose End Diameter (D) In.	Clearance Depth (E) In.
KB-43-6	-	3/8	6	13/16	5/8	7/32	7/16
-	KT-44-6	7/16	6	7/8	5/8	5/8	1/2
KB-45-3	-	1/2	3	7/8	11/16	11/16	1/2
KB-45-4	-	1/2	4	7/8	11/16	11/16	1/2
KB-104-6	KT-104-6	1/2	6	1	3/4	3/4	9/16
KB-202-6	KT-202-6	1/2	6	1	7/8	11/16	15/32
-	KT-202-9	1/2	9	1	7/8	11/16	15/32
KB-202-12	KT-202-12	1/2	12	1	7/8	11/16	15/32
KB-317-9	KT-317-9	1/2	9	1	1	11/16	7/16
KB-105-3	-	9/16	3	1	13/16	13/16	9/16
-	KT-105-6	9/16	6	1	13/16	13/16	9/16
-	KT-105-9	9/16	9	1	13/16	13/16	9/16
-	KT-105-12	9/16	12	1	13/16	13/16	9/16
-	KT-203-6	9/16	6	1 1/16	7/8	3/4	17/32
KB-203-9	KT-203-9	9/16	9	1 1/16	7/8	3/4	17/32
KB-203-12	KT-203-12	9/16	12	1 1/16	7/8	3/4	17/32
-	KT-318-6	9/16	6	1 1/8	1	3/4	9/16
KB-318-12	-	9/16	12	1 1/8	1	3/4	9/16
KB-205-6	KT-205-6	5/8	6	1 1/8	7/8	7/8	19/32
KB-205-12	KT-205-12	5/8	12	1 1/8	7/8	7/8	19/32
KB-320-6	KT-320-6	5/8	6	1 3/16	1	27/32	5/8
-	KT-320-9	5/8	9	1 3/16	1	27/32	5/8
-	KT-320-12	5/8	12	1 3/16	1	27/32	5/8
KB-321-6	-	11/16	6	1 1/4	1	1	11/16
KB-322-3	-	3/4	3	1 1/4	1 1/8	1 1/8	11/16
KB-322-6	KT-322-6	3/4	6	1 1/4	1 1/8	1 1/8	11/16
-	KT-322-9	3/4	9	1 1/4	1 1/8	1 1/8	11/16

Metric 6 Point, Standard & Tension Type - Extension

Part Number Standard	Part Number Tension	Hex Opening mm	Shank Length (A) mm	Socket Length (B) mm	Socket Diameter (C) mm	Nose End Diameter (D) mm	Clearance Depth (E) mm
KB-6-10m-6	KT-6-10m-6	10	152	20.6	19.1	15.1	9.5
-	KT-6-10m-9	10	229	20.6	19.1	15.1	9.5
-	KT-6-10m-12	10	305	20.6	19.1	15.1	9.5
KB-7-11m-6	-	11	152	23.8	22.2	15.9	10.3
KB-7-13m-3	-	13	76	25.4	22.2	17.5	11.9
KB-7-13m-6	KT-7-13m-6	13	152	25.4	22.2	17.5	11.9
KB-7-13m-9	KT-7-13m-9	13	229	25.4	22.2	17.5	11.9
KB-7-13m-12	-	13	305	25.4	22.2	17.5	11.9
KB-7-14m-6	KT-7-14m-6	14	152	27.0	22.2	19.1	13.5
-	KT-7-14m-12	14	305	27.0	22.2	19.1	14.3
-	KT-7-15m-6	15	152	27.0	22.2	19.1	14.3
KB-8-15m-6	KT-8-15m-6	15	152	28.6	25.4	19.8	14.3
KB-8-15m-9	KT-8-15m-9	15	229	28.6	25.4	19.8	14.3
KB-8-15m-12	KT-8-15m-12	15	305	28.6	25.4	19.8	14.3
KB-8-16m-6	KT-8-16m-6	16	152	30.2	25.4	21.4	15.9
KB-8-16m-9	KT-8-16m-9	16	229	30.2	25.4	21.4	15.9
-	KT-8-16m-12	16	305	30.2	25.4	21.4	15.9



Solutions

What is the benefit of a tension sleeve?

A universal wrench with a tension sleeve holds the socket at the desired driving angle while aligning the tool and fastener. Other universal wrench sockets can "flop" making engagement difficult.



What types of magnetic sockets does Apex offer?

In addition to a fixed magnet socket (center), Apex offers spring-loaded (left) and cylindrical (right) magnet styles that allow the bolt to recess into the socket body as the nut is driven down. Fixed magnet sockets are designated by a M- part number prefix, spring-loaded by MB- prefix and cylindrical by a SM- prefix.



Does Apex offer thin wall sockets?

Thin wall sockets accommodate countersunk or limited clearance nut or bolt locations. Many of these sockets have a shouldered body design that can fit in tight quarters.



When can I use a universal adapter?

A universal adapter gives all of your sockets the versatility of a universal wrench. Universal adapters must not be used with impact drivers.

(See page 39.)



Does Apex offer bolt clearance nutsetters?

Bolt clearance nutsetters allow the bolt or stud to recess into the nutsetter body as the nut is driven down. Bolt clearance nutsetters are prefixed with the numbers 6B- (See page 28.)

Does Apex offer Torx® sockets?

Like Torx® screws, Torx® bolts are becoming commonplace in a variety of assembly applications. Apex offers a wide variety of Torx® sockets. (See page 39.)



What is the advantage of surface drive sockets?

Use surface drive sockets if tools are still running when they engage the fasteners (such as on this multi-spindle machine). They're easier to engage and will result in less tool wear.



If the tool you need does not appear in this catalog, give us a call. The odds are, we may have what you need as a non-catalog item. If not, our experienced staff of tooling experts can design and manufacture "specials" to meet the needs of your specific application. Give us a call at 1-800-845-5629 or visit our website www.apex-tools.com.

Does Apex offer a complete line of extensions?

Apex features a wide selection of extension lengths, styles and sizes.

(See the Table of Contents for a complete listing.)



Can I use my extensions, adapters and universals with impact drivers?

Quality design and construction give Apex universal wrenches a long service life and durability. Remember, universal wrenches, extensions and adapters are not to be used with impact drivers.



Does Apex offer mar resistant bits and sockets?

Apex can nylon coat just about any of our bits or sockets. Nylon offers excellent mar resistance for assemblies that have painted, varnished or chromed surfaces. Nylon also offers some safety benefits by covering tool junctions. (See pages 68-76 for more information)



In this section...



Impact Sockets



Apex industrial grade impact sockets are available in a wide range of lengths and wall thicknesses, and with single or double hex openings. Square openings are available in select sizes.



Fixed Magnetic Impact Sockets



Magnetic sockets hold the fastener in driving position, even when working straight down. Time-wasting motions are eliminated when starting fasteners or working in hard-to-reach areas. These sockets are identified with a M- prefix.



Magnetic Bolt Clearance Impact Sockets



As the nut is run down, a spring-loaded or hollow cylinder magnet allows the bolt or stud to retract into the socket body. Nuts are held firmly in the socket. These sockets are identified with a MB- prefix.



Surface Drive Sockets



Large openings on the six corners of the opening create a "floating" action that allows the socket to slip quickly and easily onto the nut or bolt. Ideal for compensating for imperfect alignment between the tool and fastener. Not generally recommended for impact use. These sockets are identified with a SF- prefix.



Fast Lead Impact Sockets



Designed for power tool and multiple spindle power tools, a specially tapered opening provides complete engagement with the nut almost instantly upon engagement. This speeds productivity and extends tool life. Engagement is possible without starting and stopping the tool for each nut. These sockets are identified with a FL- prefix.



Special Sockets

You'll find Spline, Torx®, tap holding, Budd Wheel, grease fitting and other sockets for special applications.



Extensions and Adapters

Apex provides the accessories needed to adapt sockets to nearly every tool and application.



Square Drive Universal Wrenches

Hard-to-reach areas are no problem with Apex's wide range of universal and extension universal wrenches.

1/4" Square Drive Sockets, SAE

Standard Length, 6 Point and Double Hex



Part Number	Part Number Double Hex	Hex Opening In.	Overall Length (A)	Diameter Nose End (B)	Diameter Drive End (C)	Opening Depth (D)
1105	-	5/32	7/8	1/4	1/2	3/32
1106	1106-D	3/16	7/8	5/16	1/2	3/32
1107	1107-D	7/32	7/8	3/8	1/2	5/32
1108	1108-D	1/4	7/8	3/8	1/2	5/32
X-1108*	-	1/4	7/8	3/8	1/2	5/32
1109	1109-D	9/32	1	7/16	1/2	3/16
1110	1110-D	5/16	1	1/2	1/2	3/16
X-1110*	-	5/16	1	1/2	1/2	3/16
HA-510	-	5/16	7/8	7/16	7/16	3/16
1111	1111-D	11/32	1	1/2	1/2	3/16
1112	1112-D	3/8	1	9/16	9/16	1/4
1113	-	13/32	1	5/8	5/8	1/4
1114	1114-D	7/16	1	5/8	5/8	9/32
1116	1116-D	1/2	1	11/16	11/16	11/32
1118	-	9/16	1	13/16	13/16	7/16
1120	-	5/8	1	7/8	7/8	7/16

* Parts have a harder heat treat.

Long Length, 6 Point and Double Hex



Part Number	Part Number Double Hex	Hex Opening In.	Overall Length (A)	Diameter Nose End (B)	Diameter Drive End (C)	Opening Depth (D)
1206	1206-D	3/16	1 3/4	5/16	1/2	3/32
1207	-	7/32	1 3/4	3/8	1/2	5/32
1208	1208-D	1/4	1 3/4	3/8	1/2	5/32
1209	1209-D	9/32	1 3/4	7/16	1/2	3/16
1210	1210-D	5/16	1 3/4	1/2	1/2	3/16
1211	-	11/32	1 3/4	1/2	1/2	3/16
1212	1212-D	3/8	1 3/4	9/16	9/16	1/4
1213	-	13/32	1 3/4	5/8	5/8	1/4
1214	-	7/16	1 3/4	5/8	5/8	9/32
1216	1216-D	1/2	1 3/4	11/16	11/16	11/32
1218	-	9/16	1 3/4	13/16	13/16	7/16

Extra Long Length, 6 Point and Double Hex



Part Number	Part Number Double Hex	Hex Opening In.	Overall Length (A)	Diameter Nose End (B)	Diameter Drive End (C)	Opening Depth (D)
1308	1308-D	1/4	3	3/8	1/2	5/32
1310	-	5/16	3	1/2	1/2	3/16
1311	1311-D	11/32	3	1/2	1/2	3/16
1312	-	3/8	3	9/16	9/16	1/4
1313	-	13/32	3	9/16	9/16	1/4
1314	-	7/16	3	5/8	5/8	9/32
1316	-	1/2	3	11/16	11/16	11/32
1318	-	9/16	3	13/16	13/16	7/16
1320	-	5/8	3	7/8	7/8	7/16

Magnetic, Standard Length, 6 Point



Part Number	Part Number Double Hex	Hex Opening In.	Overall Length (A)	Diameter Nose End (B)	Diameter Drive End (C)	Opening Depth (D)
M-1105	5/32	7/8	5/16	1/2	3/32	
M-1106	3/16	7/8	5/16	1/2	3/32	
M-1107	7/32	7/8	3/8	1/2	5/32	
MX-1108*	1/4	7/8	3/8	1/2	5/32	
M-1108-E*	1/4	7/8	3/8	1/2	5/32	
MX-1109*	9/32	1	7/16	1/2	3/16	
MHA-510	5/16	7/8	7/16	7/16	1/8	
M-1110	5/16	1	1/2	1/2	3/16	
MX-1110*	5/16	1	1/2	1/2	3/16	
MX-1111	11/32	1	1/2	1/2	3/16	
M-1112	3/8	1	9/16	9/16	1/4	
MX-1112*	3/8	1	9/16	9/16	1/4	
M-1114	7/16	1	5/8	5/8	9/32	
M-1116	1/2	1	11/16	11/16	11/32	
M-1118	9/16	1	11/16	11/16	11/32	

* Parts have a harder heat treat; MX-1108-E has no lead-in chamfer.

Magnetic, Long & Extra Long Length, 6 Point



Part Number	Part Number Double Hex	Hex Opening In.	Overall Length (A)	Diameter Nose End (B)	Diameter Drive End (C)	Opening Depth (D)
-	MB-1206	3/16	1 3/4	5/16	1/2	5/32
M-1208	MB-1208	1/4	1 3/4	3/8	1/2	5/32
-	MB-1308	1/4	3	3/8	1/2	5/32
M-1209	MB-1209	9/32	1 3/4	7/16	1/2	3/16
M-1210	MB-1210	5/16	1 3/4	1/2	1/2	3/16
-	MB-1211	11/32	1 3/4	1/2	1/2	3/16
-	MB-1311	11/32	3	1/2	1/2	3/16
M-1212	MB-1212	3/8	1 3/4	9/16	9/16	1/4
-	MB-1312	3/8	3	9/16	9/16	1/4
M-1214	MB-1214	7/16	1 3/4	5/8	5/8	9/32
-	MB-1314	7/16	3	5/8	5/8	9/32
-	MB-1216	1/2	1 3/4	11/16	11/16	11/32
-	MB-1218	9/16	1 3/4	13/16	13/16	7/16

* For explanation of magnets, see Tool Tip on page 33.

Surface Drive & Fast Lead, Standard & Long Length

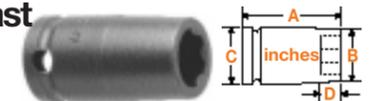

Part No. Surface Drive	Part No. Fast Lead	Hex Opening In.	Overall Length (A)	Diameter Nose End (B)	Diameter Drive End (C)	Opening Depth (D)
-	FL-1108	1/4	7/8	3/8	1/2	5/32
-	FL-1109	9/32	7/8	3/8	1/2	5/32
-	FL-1110	5/16	1	1/2	1/2	3/16
SF-1112	FL-1112	3/8	1	9/16	9/16	1/4
-	FL-1212	3/8	1 3/4	9/16	9/16	1/4
-	FL-1114	7/16	1	5/8	5/8	9/32
-	FL-1214	7/16	1 3/4	5/8	5/8	9/32
SF-1116	FL-1116	1/2	1	11/16	11/16	11/32
-	FL-1216	1/2	1 3/4	11/16	11/16	11/32

BOLDED part numbers are industry popular items and are followed by common variations which may vary in price and availability.

1/4" Sq. Dr. Sockets For SAE Sheet Metal Screws

6 Point & 6 Point Magnetic, For Predrilled Holes*



Part Number 6 Point	Part Number Magnetic	Hex Opening In.	Overall Length (A)	Diameter Nose End (B)	Diameter Drive End (C)	Opening Depth (D)
-	M1E06	3/16	7/8	5/16	1/2	3/32
-	M1E07	7/32	7/8	3/8	1/2	5/32
1E08	M1E08	1/4	7/8	3/8	1/2	5/32
1E10	M1E10	5/16	7/8	1/2	1/2	3/16
-	M1E11	11/32	1	1/2	1/2	3/16
-	M1E12	3/8	1	5/8	5/8	1/4
-	M1E14	7/16	1	11/16	11/16	9/32
-	M1E16	1/2	1	11/16	11/16	11/32

*Sockets for predrilled holes are intermediate hardness; sockets for self-drilling and tapping screws are maximum hardness.

6 Point & 6 Point Magnetic, for Self-Drilling and Tapping Screws*



Part Number 6 Point	Part Number Magnetic	Hex Opening In.	Overall Length (A)	Diameter Nose End (B)	Diameter Drive End (C)	Opening Depth (D)
1P06	M1P06	3/16	7/8	5/16	1/2	3/32
1P07	M1P07	7/32	7/8	3/8	1/2	5/32
1P08	M1P08	1/4	7/8	7/16	1/2	5/32
-	M1P09	9/32	7/8	1/2	1/2	3/16
1P10	M1P10	5/16	7/8	1/2	1/2	3/16
1P11	M1P11	11/32	1	1/2	1/2	3/16
1P12	M1P12	3/8	1	5/8	5/8	1/4
1P14	M1P14	7/16	1	11/16	11/16	9/32
1P16	M1P16	1/2	1	11/16	11/16	11/32

*Sockets for predrilled holes are intermediate hardness; sockets for self-drilling and tapping screws are maximum hardness.

BOLDED part numbers are industry popular items and are followed by common variations which may vary in price and availability.

1/4" Sq. Dr. Sockets For SAE Square Nuts

Single Square & Double Square



Part Number Square	Part No. Double Square	Hex Opening In.	Overall Length (A)	Diameter Nose End (B)	Diameter Drive End (C)	Opening Depth (D)
1608	1608-D	1/4	1	1/2	1/2	3/16
1612	1612-D	3/8	1	3/4	3/4	1/4

1/4" Square Drive Universal Wrenches, SAE

6 Point and Double Hex

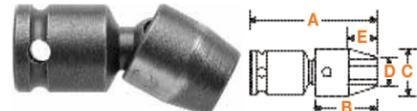

Part Number 6 Point	Part Number Double Hex	Hex Opening In.	Overall Length (A)	Socket Length (B)	Socket Diameter (C)	Nose End Diameter (D)	Clearance Depth (E)
SA-25	SA-25-D	1/4	1 7/32	3/4	5/8	3/8	3/8
SA-26	SA-26-D	5/16	1 17/32	3/4	5/8	7/16	3/8
SA-28	SA-28-D	3/8	1 19/32	13/16	5/8	17/32	7/16
SA-29	SA-29-D	7/16	1 21/32	7/8	5/8	5/8	1/2
SA-30	SA-30-D	1/2	1 21/32	7/8	11/16	11/16	1/2
SA-65	-	9/16	1 21/32	7/8	11/16	11/16	1/2

Universal wrenches must not be used with impact drivers. Maximum operating angle is 30°.

1/4" Square Drive Sockets, Metric

Standard Length, 6 Point and Double Hex



Part Number 6 Point	Part Number Double Hex	Hex Opening mm	Overall Length (A)	Diameter Nose End (B)	Diameter Drive End (C)	Opening Depth (D)
3.5mm11	-	3.5	22.2	6.4	12.7	2.4
4mm11	-	4	22.2	6.4	12.7	2.4
4.5mm11	-	4.5	22.2	7.9	12.7	2.4
5mm11	-	5	22.2	8.7	12.7	3.9
5.5mm11	-	5.5	22.2	9.5	12.7	3.9
6mm11	6mm11-D	6	22.2	9.5	12.7	3.9
7mm11	7mm11-D	7	22.2	11.1	12.7	4.8
8mm11	8mm11-D	8	25.4	12.7	12.7	4.8
9mm11	9mm11-D	9	25.4	14.3	14.3	4.8
10mm11	10mm11-D	10	25.4	15.9	15.9	6.4
OS-10mm11	-	10	25.4	14.3	14.3	6.4
11mm11	11mm11-D	11	25.4	15.9	15.9	7.2
12mm11	12mm11-D	12	25.4	17.5	17.5	7.2
13mm11	13mm11-D	13	25.4	19.1	19.1	8.7
14mm11	14mm11-D	14	25.4	20.6	20.6	11.1
15mm11	-	15	25.4	22.2	22.2	11.1
16mm11	-	16	25.4	22.2	22.2	11.1

Long Length, 6 Point and Double Hex



Part Number 6 Point	Part Number Double Hex	Hex Opening mm	Overall Length (A)	Diameter Nose End (B)	Diameter Drive End (C)	Opening Depth (D)
5mm21	-	5	44.4	8.7	12.7	3.9
5.5mm21	-	5.5	44.4	9.5	12.7	3.9
6mm21	-	6	44.4	9.5	12.7	3.9
7mm21	-	7	44.4	11.1	12.7	4.8
8mm21	8mm21-D	8	44.4	12.7	12.7	4.8
9mm21	9mm21-D	9	44.4	14.3	14.3	4.8
10mm21	10mm21-D	10	44.4	15.9	15.9	6.4
11mm21	-	11	44.4	15.9	15.9	7.2
12mm21	-	12	44.4	17.5	17.5	7.2
13mm21	13mm21-D	13	44.4	19.1	19.1	8.7
14mm21	-	14	44.4	20.6	20.6	11.1
15mm21	15mm21-D	15	50.8	22.2	22.2	11.1
16mm21	-	16	50.8	22.2	22.2	11.1

Magnetic, Standard Length, 6 Point



Part Number Fixed Magnet	Hex Opening mm	Overall Length (A)	Diameter Nose End (B)	Diameter Drive End (C)	Opening Depth (D)
M-5mm11	5	22.2	8.7	12.7	3.9
M-5.5mm11	5.5	22.2	9.5	12.7	3.9
M-6mm11	6	22.2	9.5	12.7	3.9
M-7mm11	7	22.2	11.9	12.7	4.8
M-8mm11	8	25.4	12.7	12.7	4.8
M-9mm11	9	25.4	14.3	14.3	4.8
M-10mm11	10	25.4	15.9	15.9	6.4
M-11mm11	11	25.4	15.9	15.9	7.2
M-12mm11	12	25.4	17.5	17.5	7.2
M-13mm11	13	25.4	19.1	19.1	8.7
M-14mm11	14	25.4	20.6	20.6	11.1
M-15mm11	15	25.4	22.2	22.2	11.1

Magnetic, Long Length, 6 Point



Part No. Fixed Magnet	Part No. Magnetic Bolt Clearance	Hex Opening mm	Overall Length (A)	Diameter Nose End (B)	Diameter Drive End (C)	Opening Depth (D)
-	MB-5mm21	5	44.4	8.7	12.7	3.9
-	MB-5.5mm21	5.5	44.4	9.5	12.7	3.9
M-6mm21	MB-6mm21	6	44.4	9.5	12.7	3.9
M-7mm21	MB-7mm21	7	44.4	11.9	12.7	4.8
M-8mm21	MB-8mm21	8	44.4	12.7	12.7	4.8
M-9mm21	MB-9mm21	9	44.4	14.3	14.3	4.8
M-10mm21	MB-10mm21	10	44.4	15.9	15.9	6.4
-	**OSMB-10mm21	10	44.4	14.2	14.2	6.4
M-11mm21	MB-11mm21	11	44.4	15.9	15.9	7.2
M-12mm21	MB-12mm21	12	44.4	17.5	17.5	7.2
M-13mm21	MB-13mm21	13	44.4	19.1	19.1	8.7
-	MB-14mm21	14	44.4	20.6	20.6	11.1
-	MB-15mm21	15	50.8	22.2	22.2	11.1
-	MB-16mm21	16	50.8	22.2	22.2	11.1

* For an explanation of magnets, see Tool Tip on page 33.
** No ring groove.

Surface Drive, Standard and Long Length



Part Number Surface Drive	Hex Opening mm	Overall Length (A)	Diameter Nose End (B)	Diameter Drive End (C)	Opening Depth (D)
SF-8mm11	8	25.4	12.7	12.7	4.7
SF-10mm11	10	25.4	15.9	15.9	6.4
SF-10mm21	10	44.4	15.9	15.9	6.4
SF-12mm21	11	44.4	17.5	15.9	7.2
SF-13mm11	13	25.4	19.1	19.1	8.7
SF-13mm21	13	44.4	19.1	19.1	8.7
SF-15mm11	15	25.4	22.2	22.2	11.1

BOLDED part numbers are industry popular items and are followed by common variations which may vary in price and availability.

1/4" Sq. Dr. Sockets For Metric Sheet Metal Screws

6 Point and 6 Point Magnetic



Part Number 6 Point	Part Number Magnetic	Hex Opening mm	Overall Length (A)	Diameter Nose End (B)	Diameter Drive End (C)	Opening Depth (D)
3.5mmE1	-	3.5	22.2	6.4	12.7	2.4
4mmE1	M-4mmE1	4	22.2	6.4	12.7	2.4
-	M-5mmE1	5	22.2	8.7	12.7	3.9
5.5mmE1	M-5.5mmE1	5.5	22.2	9.5	12.7	3.9
6mmE1	M-6mmE1	6	22.2	9.5	12.7	3.9
7mmE1	M-7mmE1	7	22.2	11.1	12.7	4.8
-	MR-7mmE1*	7	22.2	11.1	12.7	4.8
8mmE1	M-8mmE1	8	25.4	12.7	12.7	4.8
9mmE1	M-9mmE1	9	25.4	14.3	14.3	4.8
10mmE1	M-10mmE1	10	25.4	15.9	15.9	6.4
11mmE1	M-11mmE1	11	25.4	17.5	17.5	7.2
12mmE1	M-12mmE1	12	25.4	17.5	17.5	7.2
13mmE1	M-13mmE1	13	25.4	19.1	19.1	8.7

*MR-7mmE1 has stronger magnet

1/4" Sq. Dr. Universal Wrenches, Metric

6 Point



Part Number 6 Point	Hex Opening mm	Overall Length (A)	Socket Length (B)	Socket Diameter (C)	Nose End Diameter (D)	Opening Depth (E)
SA-15-6m	6	31	19.1	15.9	9.5	9.5
SA-15-7m	7	31	19.1	15.9	10.3	9.5
SA-16-8m	8	38	19.1	19.1	11.1	7.9
SA-16-10m	10	40	20.6	19.1	15.1	9.5

Universal wrenches must not be used with impact drivers. Maximum operating angle is 30°.

If the tool you need does not appear in this catalog, give us a call. The odds are, we may have what you need as a non-catalog item. If not, our experienced staff of tooling experts can design and manufacture "specials" to meet the needs of your specific application. Give us a call at 1-800-845-5629 or visit our website www.apex-tools.com.

BOLDED part numbers are industry popular items and are followed by common variations which may vary in price and availability.

1/4" Sq. Dr. Sockets For Spline Fasteners

Standard and Long Length



Part Number	Spline Size	Nominal Size	Overall Length (A)		Diameter Nose End (B)		Diameter Drive End (C)	
			In.	mm	In.	mm	In.	mm
CMS-1507	7	7/32	2	51	21/64	8	7/16	11
CMS-1408	8	1/4	7/8	22	3/8	10	7/16	11
CMS-1508	8	1/4	2	51	3/8	10	7/16	11
CMS-1409	9	9/32	7/8	22	7/16	11	7/16	11
CMS-1509	9	9/32	2	51	7/16	11	7/16	11
CMS-1410	10	5/16	7/8	22	29/64	12	29/64	12
CMS-1510	10	5/16	2	51	29/64	12	29/64	12
CMS-1412	12	3/8	7/8	22	17/32	14	17/32	14
CMS-1414	14	7/16	1	25	39/64	16	39/64	16

Apex spline sockets conform to military specifications MS-37787 and MIL-W-8982C.

1/4" Sq. Dr. Torx® Sockets

For External Torx Screws



Part Number	Driver Size	Overall Length (A)	Nose End Diameter (B)		Drive End Diameter (C)		
		In.	mm	In.	mm	In.	mm
TX-1104	E-4	1	25.4	1/4	6.4	1/2	12.7
TX-1105	E-5	1	25.4	1/4	6.4	1/2	12.7
TX-1106	E-6	1	25.4	5/16	7.9	1/2	12.7
TX-1108	E-8	1	25.4	3/8	9.5	1/2	12.7
TX-1110	E-10	1	25.4	9/16	14.3	9/16	14.3
TX-1112	E-12	1	25.4	5/8	15.9	5/8	15.9

For External Torx Screws, Thin Wall



Part Number	Driver Size	Overall Length (A)	Nose End Diameter (B)		Drive End Diameter (C)		
		In.	mm	In.	mm	In.	mm
TX-1404	E-4	1	25.4	1/4	6.4	1/2	12.7
TX-1405	E-5	1	25.4	1/4	6.4	1/2	12.7
TX-1406	E-6	1	25.4	5/16	7.9	1/2	12.7
TX-1407	E-7	1	25.4	5/16	7.9	1/2	12.7
TX-1408	E-8	1	25.4	3/8	9.5	1/2	12.7
TX-1410	E-10	1	25.4	1/2	12.7	1/2	12.7
TX-1411	E-11	1	25.4	1/2	12.7	1/2	12.7
TX-1412	E-12	1	25.4	9/16	14.3	9/16	14.3

For Torx Nuts



Part Number	Driver Size	Overall Length (A)	Nose End Diameter (B)		Drive End Diameter (C)		
		In.	mm	In.	mm	In.	mm
TX-1E05	E-5	7/8	22.2	3/8	9.5	1/2	12.7
TX-1E06	E-6	7/8	22.2	7/16	11.1	1/2	12.7
TX-1E08	E-8	7/8	22.2	1/2	12.7	1/2	12.7

Sockets for Torx® nuts have a larger lead-in chamfer than sockets for external Torx® screws. Most Torx® sockets have a DIN (pin and o-ring) groove.

BOLDED part numbers are industry popular items and are followed by common variations which may vary in price and availability.

1/4" Sq. Dr. Extensions

7/8" to 14" (22mm to 356mm) Length



Part Number	Male Square In.	Type of Lock	Overall Length mm	
			In.	mm
EX-252	1/4	Pin	7/8	22
EX-252-B	1/4	Ball	1	25
EX-255-2	1/4	Pin	2	51
EX-255-B-2	1/4	Ball	2	51
EX-255-3	1/4	Pin	3	76
EX-255-4	1/4	Pin	4	102
EX-255-B-4	1/4	Ball	4	102
EX-255-6	1/4	Pin	6	152
EX-255-B-6	1/4	Ball	6	152
EX-255-8	1/4	Pin	8	203
EX-255-10	1/4	Pin	10	254
EX-255-12	1/4	Pin	12	305
EX-255-14	1/4	Pin	14	356

1/4" Sq. Dr. Adapters

1/4" to 3/8" Male Square



Part Number	Male Square In.	Female Square In.	Type of Lock	Overall Length mm	
				In.	mm
EX-372	3/8	1/4	Pin	1	0
EX-372-B	3/8	1/4	Ball	1	25

1/4" Sq. Dr. Universal Adapters

Male Square to Female Square



Part Number	Male Sq. In.	Female Sq. In.	Type of Lock	Overall Length mm		Largest Diameter mm	
				In.	mm	In.	mm
MF-25	1/4	1/4	Pin	1 5/8	41	5/8	16
MF-25B	1/4	1/4	Ball	1 5/8	41	5/8	16

Universal wrenches must not be used with impact drivers. Maximum operating angle is 30°.

3/8" Square Drive Sockets, SAE

6 Point & Double Hex, Short and Standard Length



Part Number 6 Point	Part Number Double Hex	Hex Opening In.	Overall Length (A)	Diameter Nose End (B)	Diameter Drive End (C)	Opening Depth (D)
3108	3108-D	1/4	1 1/4	7/16	3/4	5/32
3109	-	9/32	1 1/4	7/16	3/4	3/16
3010	-	5/16	7/8	1/2	3/4	3/16
3110	3110-D	5/16	1 1/4	1/2	3/4	3/16
3111	-	11/32	1 1/4	1/2	3/4	3/16
3012	3012-D	3/8	7/8	19/32	3/4	3/16
3112	3112-D	3/8	1 1/4	19/32	3/4	1/4
3113	3113-D	13/32	1 1/2	11/16	3/4	1/4
3014	3014-D	7/16	7/8	11/16	3/4	9/32
3114	3114-D	7/16	1 1/2	11/16	3/4	9/32
SW-604	-	7/16	1 1/2	21/32	3/4	9/32
3016	3016-D	1/2	7/8	13/16	13/16	5/16
3116	3116-D	1/2	1 1/2	13/16	13/16	11/32
HC-3816	-	1/2	1 1/2	11/16	11/16	11/32
3117	-	17/32	1 1/2	13/16	13/16	11/32
3018	3018-D	9/16	7/8	7/8	7/8	5/16
3118	-	9/16	1 1/2	7/8	7/8	7/16
SW-343	-	9/16	1 1/2	3/4	3/4	7/16
SW-605	SW-605-D	9/16	1 1/2	3/4	13/16	7/16
3119	-	19/32	1 1/2	7/8	7/8	7/16
3020	3020-D	5/8	1	15/16	15/16	7/16
3120	3120-D	5/8	1 1/2	15/16	15/16	7/16
HC-3520*	-	5/8	2 3/8	7/8	7/8	7/32
3022	3022-D	11/16	1	1	1	7/16
3122	-	11/16	1 1/2	1	1	7/16
3024	3024-D	3/4	1	1 1/16	1 1/16	7/16
3124	3124-D	3/4	1 1/2	1 1/16	1 1/16	15/32
3126	-	13/16	1 1/2	1 1/8	1 1/8	7/16
3028	3028-D	7/8	1	1 1/4	1 1/4	7/16

*HC-3520 is spark plug socket.

6 Point & Double Hex, Thin Wall, Standard Length



Part Number 6 Point	Part Number Double Hex	Hex Opening In.	Overall Length (A)	Diameter Nose End (B)	Diameter Drive End (C)	Opening Depth (D)
3408	3408-D	1/4	1 1/4	7/16	3/4	5/32
3409	-	9/32	1 1/4	7/16	3/4	3/16
3410	3410-D	5/16	1 1/4	1/2	3/4	3/16
OS-3410*	-	5/16	1 1/4	7/16	19/32	3/16
3412	3412-D	3/8	1 1/2	19/32	3/4	1/4
3414	3414-D	7/16	1 1/2	5/8	3/4	9/32
3416	3416-D	1/2	1 1/2	3/4	3/4	11/32
3418	3418-D	9/16	1 1/2	25/32	13/16	7/16
3420	3420-D	5/8	1 1/2	7/8	7/8	7/16
3424	3424-D	3/4	1 1/2	1	1	15/32
3426	-	13/16	1 1/2	1 1/8	1 1/8	17/32
3428	-	7/8	1 1/2	1 3/16	1 1/4	9/16
3430	3430-D	15/16	1 1/2	1 5/16	1 5/16	5/8
3432	-	1	1 1/2	1 3/8	1 3/8	5/8
3434	-	1 1/16	1 1/2	1 1/2	1 1/2	11/16

*No ring groove.

6 Point & Double Hex, Long and Extra Long Length



Part Number 6 Point	Part Number Double Hex	Hex Opening In.	Overall Length (A)	Diameter Nose End (B)	Diameter Drive End (C)	Opening Depth (D)
3208	3208-D	1/4	2	7/16	3/4	5/32
3308	-	1/4	3 1/2	7/16	3/4	5/32
3209	-	9/32	2	7/16	3/4	3/16
3210	3210-D	5/16	2	1/2	3/4	3/16
3310	3310-D	5/16	3 1/2	1/2	3/4	3/16
OS-3310-D*	-	5/16	3 1/2	15/32	5/8	3/16
3211	-	11/32	2	1/2	3/4	3/16
3311	-	11/32	3 1/2	1/2	3/4	3/16
3212	3212-D	3/8	2	19/32	3/4	1/4
3312	3312-D	3/8	3 1/2	19/32	3/4	1/4
3214	3214-D	7/16	2	11/16	3/4	9/32
3314	3314-D	7/16	3 1/2	11/16	3/4	9/32
3216	3216-D	1/2	2	13/16	13/16	11/32
3316	3316-D	1/2	3 1/2	13/16	13/16	11/32
3218	3218-D	9/16	2	7/8	7/8	7/16
3318	3318-D	9/16	3 1/2	7/8	7/8	7/16
3220	3220-D	5/8	2	15/16	15/16	7/16
3320	3320-D	5/8	3 1/2	15/16	15/16	7/16
3222	3222-D	11/16	2	1	1	7/16
3322	3322-D	11/16	3 1/2	1	1	7/16
3224	3224-D	3/4	2	1 1/16	1 1/16	15/32
3324	3324-D	3/4	3 1/2	1 1/16	1 1/16	15/32
3226	3226-D	13/16	2	1 1/4	1 1/4	17/32
3326	3326-D	13/16	3 1/2	1 1/4	1 1/4	17/32
3228	3228-D	7/8	2	1 1/4	1 1/4	9/16
3328	-	7/8	3 1/2	1 1/4	1 1/4	9/16

*No ring groove.

6 Point & Double Hex, Thin Wall, Long Length

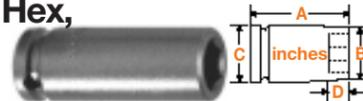

Part Number 6 Point	Part Number Double Hex	Hex Opening In.	Overall Length (A)	Diameter Nose End (B)	Diameter Drive End (C)	Opening Depth (D)
3510	-	5/16	2	1/2	3/4	3/16
3511	-	11/32	2	1/2	3/4	3/16
3512	3512-D	3/8	2	19/32	3/4	1/4
3514	3514-D	7/16	2	5/8	3/4	9/32
3516	3516-D	1/2	2	3/4	3/4	11/32
3518	3518-D	9/16	2	25/32	13/16	7/16
3524	3524-D	3/4	2	1	1	15/32
3530	-	15/16	2	1 5/16	1 5/16	5/8
3532	-	1	2	1 3/8	1 3/8	5/8
3534	-	1 1/16	2	1 1/2	1 1/2	11/16

BOLDED part numbers are industry popular items and are followed by common variations which may vary in price and availability.

3/8" Square Drive Sockets, SAE

Magnetic, Short and Standard Length



Part Number Fixed Magnet	Hex Opening In.	Overall Length (A)	Diameter Nose End (B)	Diameter Drive End (C)	Opening Depth (D)
M-3108	1/4	1 1/4	7/16	3/4	5/32
M-3109	9/32	1 1/4	7/16	3/4	3/16
M-3110	5/16	1 1/4	1/2	3/4	3/16
M-3012	3/8	7/8	19/32	3/4	3/16
M-3112	3/8	1 1/4	19/32	3/4	1/4
M-3014	7/16	7/8	11/16	3/4	9/32
M-3114	7/16	1 1/2	11/16	3/4	9/32
MSW-604	7/16	1 1/2	21/32	3/4	9/32
M-3016	1/2	7/8	13/16	13/16	5/16
M-3116	1/2	1 1/2	13/16	13/16	11/32
MHC-3816	1/2	1 1/2	11/16	11/16	11/32
M-3018	9/16	7/8	7/8	7/8	5/16
M-3118	9/16	1 1/2	7/8	7/8	7/16
MSW-343	9/16	1 1/2	3/4	3/4	7/16
M-3120	5/8	1 1/2	15/16	15/16	7/16

Magnetic, Thin Wall, Standard Length



Part Number Fixed Magnet	Hex Opening In.	Overall Length (A)	Diameter Nose End (B)	Diameter Drive End (C)	Opening Depth (D)
M-3408	1/4	1 1/4	7/16	3/4	5/32
M-3410	5/16	1 1/4	1/2	3/4	3/16
OSM-3410*	5/16	1 1/4	7/16	19/32	3/16
M-3411	11/32	1 1/4	1/2	3/4	3/16
M-3412	3/8	1 1/2	19/32	3/4	1/4
M-3414	7/16	1 1/2	5/8	3/4	9/32
OSM-3414*	7/16	1 1/2	5/8	5/8	9/32
M-3416	1/2	1 1/2	3/4	3/4	11/32
M-3418	9/16	1 1/2	25/32	13/16	7/16
M-3424	3/4	1 1/2	1	1	15/32
M-3426	13/16	1 1/2	1 1/8	1 1/8	17/32

*No ring groove.

Magnetic, Long Length & Extra Long Length



Part No. Fixed Magnet	Part No. Magnetic Bolt Clearance	Hex Opening In.	Overall Length (A)	Diameter Nose End (B)	Diameter Drive End (C)	Opening Depth (D)
-	MB-3210	5/16	2	1/2	3/4	3/16
M-3212	MB-3212	3/8	2	19/32	3/4	1/4
M-3214	MB-3214	7/16	2	11/16	3/4	9/32
-	MB-3314	7/16	3 1/2	11/16	3/4	9/32
M-3216	MB-3216	1/2	2	13/16	13/16	11/32
M-3218	MB-3218	9/16	2	7/8	7/8	7/16
-	MB-3318	9/16	3 1/2	7/8	7/8	7/16
-	MB-3220	5/8	2	15/16	15/16	7/16

BOLDED part numbers are industry popular items and are followed by common variations which may vary in price and availability.



Magnetic, Thin Wall, Long Length



Part No. Fixed Magnet	Part No. Magnetic Bolt Clearance	Hex Opening In.	Overall Length (A)	Diameter Nose End (B)	Diameter Drive End (C)	Opening Depth (D)
-	MB-3512	3/8	2	19/32	3/4	1/4
M-3514	MB-3514	7/16	2	5/8	3/4	9/32
-	MB-3516	1/2	2	3/4	3/4	11/32

Surface Drive & Fast Lead, Short and Standard Length

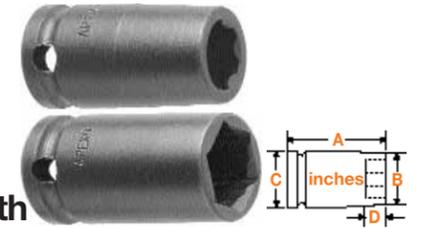

Part No. Surface Drive	Part Number Fast Lead	Hex Opening In.	Overall Length (A)	Diameter Nose End (B)	Diameter Drive End (C)	Opening Depth (D)
SF-3010	-	5/16	7/8	1/2	3/4	3/16
SF-3110	FL-3110	5/16	1 1/4	1/2	3/4	3/16
SF-3012	FL-3012	3/8	7/8	19/32	3/4	3/16
SF-3112	FL-3112	3/8	1 1/4	19/32	3/4	1/4
SF-3014	FL-3014	7/16	7/8	11/16	3/4	9/32
SF-3114	FL-3114	7/16	1 1/2	11/16	3/4	9/32
SF-3016	FL-3016	1/2	7/8	13/16	13/16	5/16
SF-3116	FL-3116	1/2	1 1/2	13/16	13/16	11/32
SF-HC3816	-	1/2	1 1/2	11/16	11/16	11/32
SF-3018	FL-3018	9/16	7/8	7/8	7/8	5/16
SF-3118	FL-3118	9/16	1 1/2	7/8	7/8	7/16
SF-3120	FL-3120	5/8	1 1/2	15/16	15/16	7/16
-	FL-3022	11/16	1	15/16	15/16	7/16
-	FL-3122	11/16	1 1/2	1	1	7/16
-	FL-3024	3/4	1	1 1/16	1 1/16	7/16
-	FL-3124	3/4	1 1/2	1 1/16	1 1/16	15/32

Surface Drive & Fast Lead, Thin Wall, Standard Length

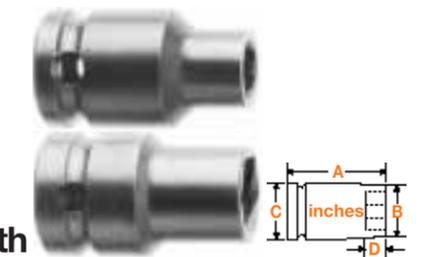

Part No. Surface Drive	Part Number Fast Lead	Hex Opening In.	Overall Length (A)	Diameter Nose End (B)	Diameter Drive End (C)	Opening Depth (D)
SF-3412	FL-3412	3/8	1 1/2	19/32	3/4	1/4
SF-3414	FL-3414	7/16	1 1/2	5/8	3/4	9/32
SF-3416	-	1/2	1 1/2	3/4	3/4	11/32
SF-3418	-	9/16	1 1/2	25/32	13/16	7/16
SF-3432	-	1	1 1/2	1 3/8	1 3/8	5/8

3/8" Sq. Dr. Sockets, SAE

Surface Drive & Fast Lead, Long and Extra Long Length

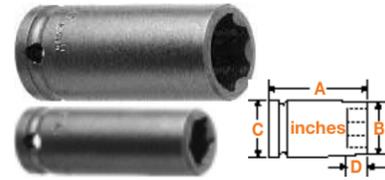

Part No. Surface Drive	Part Number Fast Lead	Hex Opening In.	Overall Length (A)	Diameter Nose End (B)	Diameter Drive End (C)	Opening Depth (D)
-	FL-3210	5/16	2	1/2	3/4	3/16
SF-3212	FL-3212	3/8	2	19/32	3/4	1/4
-	FL-3312	3/8	3 1/2	19/32	3/4	1/4
SF-3214	FL-3214	7/16	2	11/16	3/4	9/32
SF-3314	FL-3314	7/16	3 1/2	11/16	3/4	9/32
SF-3216	FL-3216	1/2	2	13/16	13/16	11/32
SF-3316	FL-3316	1/2	3 1/2	13/16	13/16	11/32
SF-3218	FL-3218	9/16	2	7/8	7/8	7/16
SF-3318	FL-3318	9/16	3 1/2	7/8	7/8	7/16
-	FL-3220	5/8	2	15/16	15/16	7/16
SF-3320	FL-3320	5/8	3 1/2	15/16	15/16	7/16
SF-3224	-	3/4	2	1 1/16	1 1/16	15/32
SF-3324	FL-3324	3/4	3 1/2	1 1/16	1 1/16	15/32
-	FL-3326	13/16	3 1/2	1 1/4	1 1/4	17/32

Surface Drive, Thin Wall, Long Length



Part No. Surface Drive	Hex Opening In.	Overall Length (A)	Diameter Nose End (B)	Diameter Drive End (C)	Opening Depth (D)
SF-3512	3/8	2	19/32	3/4	1/4
OSSF-3512*	3/8	2	19/32	19/32	1/4
SF-3514	7/16	2	5/8	3/4	9/32
OSSF-3514*	7/16	2	5/8	5/8	9/32
SF-3516	1/2	2	3/4	3/4	11/32
SF-3518	9/16	2	25/32	13/16	7/16

*No ring groove.

BOLDED part numbers are industry popular items and are followed by common variations which may vary in price and availability.

3/8" Sq. Dr. Sockets For SAE Sheet Metal Screws

6 Point & 6 Point Magnetic, For Predrilled Holes*



Part No. Surface Drive	Part Number Fast Lead	Hex Opening In.	Overall Length (A)	Diameter Nose End (B)	Diameter Drive End (C)	Opening Depth (D)
-	M3E08	1/4	1 1/4	7/16	3/4	5/32
3E10	M3E10	5/16	1 1/4	1/2	3/4	3/16
3E11	-	11/32	1 1/4	1/2	3/4	3/16
3E12	M3E12	3/8	1 1/4	19/32	3/4	1/4
3E14	M3E14	7/16	1 1/4	11/16	3/4	9/32
3E16	M3E16	1/2	1 1/2	13/16	13/16	11/32
-	M3E18	9/16	1 1/2	7/8	7/8	7/16

6 Point & 6 Point Magnetic, For Self-Tapping Screws*



Part No. Surface Drive	Part Number Fast Lead	Hex Opening In.	Overall Length (A)	Diameter Nose End (B)	Diameter Drive End (C)	Opening Depth (D)
-	M3P06	3/16	1 1/4	5/16	3/4	3/32
-	M3P07	7/32	1 1/4	3/8	3/4	5/32
-	M3P08	1/4	1 1/4	7/16	3/4	5/32
3P10	M3P10	5/16	1 1/4	1/2	3/4	3/16
3P12	M3P12	3/8	1 1/4	5/8	3/4	1/4
3P14	M3P14	7/16	1 1/4	11/16	3/4	9/32
3P16	M3P16	1/2	1 1/2	13/16	13/16	11/32
-	M3P18	9/16	1 1/2	7/8	7/8	7/16

*Sockets for predrilled holes are intermediate hardness; sockets for self-tapping screws are maximum hardness.

3/8" Sq. Dr. Sockets For SAE Square Nuts

Single Square & Double Square



Part No. Surface Drive	Part Number Fast Lead	Hex Opening In.	Overall Length (A)	Diameter Nose End (B)	Diameter Drive End (C)	Opening Depth (D)
3607	-	7/32	1 1/2	7/16	3/4	3/16
3608	-	1/4	1 1/2	1/2	3/4	3/16
3609	3609-D	9/32	1 1/2	9/16	3/4	3/16
3610	3610-D	5/16	1 1/2	5/8	3/4	1/4
3612	3612-D	3/8	1 1/2	3/4	3/4	1/4
3614	3614-D	7/16	1 1/2	7/8	7/8	9/32
3616	3616-D	1/2	1 1/2	1	1	11/32
3618	3618-D	9/16	1 1/2	1	1	7/16
3620	-	5/8	1 1/2	1 1/8	1 1/8	7/16
3624	-	3/4	1 1/2	1 3/8	1 3/8	15/32

BOLDED part numbers are industry popular items and are followed by common variations which may vary in price and availability.

3/8" Sq. Dr. Socket Sets, SAE

6 Point



APS38	8 piece, standard length: 5/16, 3/8, 7/16, 1/2, 9/16, 5/8, 11/16, 3/4
APS38L	8 piece, long length: 5/16, 3/8, 7/16, 1/2, 9/16, 5/8, 11/16, 3/4

3/8" Sq. Dr. Universal Wrenches, SAE



6 Point & 12 Point

Part Number 6 Point	Part Number 12 Point	Hex Opening In.	Overall Length (A) In.	Socket Length (B) In.	Socket Diameter (C) In.	Nose End Diameter (D) In.	Clearance Depth (E) In.
SA-120	SA-120-D	5/16	1 53/64	3/4	3/4	7/16	5/16
SA-122	SA-122-D	3/8	1 57/64	13/16	3/4	9/16	3/8
SA-200	-	3/8	1 15/16	7/8	7/8	9/16	11/32
SA-123	SA-123-D	7/16	2 1/64	15/16	3/4	19/32	1/2
SA-201	-	7/16	2	15/16	7/8	5/8	13/32
SA-124	SA-124-D	1/2	2 5/64	1	3/4	3/4	9/16
SA-202	SA-202-D	1/2	2 1/16	1	7/8	11/16	15/32
SA-125	SA-125-D	9/16	2 1/8	1	13/16	13/16	9/16
SA-203	SA-203-D	9/16	2 1/16	1 1/16	7/8	3/4	17/32
SA-302	-	9/16	2 1/8	1 1/8	1	3/4	9/16
SA-205	SA-205-D	5/8	2 1/8	1 1/8	7/8	7/8	19/32
SA-305	-	11/16	2 5/16	1 1/4	1	1	11/16
SA-306	-	3/4	2 5/16	1 1/4	1 1/8	1 1/8	11/16

Universal wrenches must not be used with impact drivers. Maximum operating angle is 30°.

3/8" Sq. Dr. Universal Wrench Set, SAE



6 Point

APU37	7 piece, standard length: 3/8, 7/16, 1/2, 9/16, 5/8, 11/16, 3/4
-------	--

BOLDED part numbers are industry popular items and are followed by common variations which may vary in price and availability.



3/8" Sq. Dr. Universal Wrenches, SAE - Extension

6 Point & Double Hex, Standard and Tension Type



Part Number Standard	Part Number Tension	Hex Opening In.	Overall Length (A) In.	Socket Length (B) In.	Socket Dia. (C) In.	Nose End Dia. (D) In.	Clearance Depth (E) In.
KA-43-6	KD-43-6	3/8	6	13/16	5/8	17/32	7/16
KA-44-3	-	7/16	3	7/8	5/8	5/8	1/2
KA-44-4	-	7/16	4	7/8	5/8	5/8	1/2
KA-44-6	KD-44-6	7/16	6	7/8	5/8	5/8	1/2
KA-103-6	KD-103-6	7/16	6	15/16	3/4	19/32	1/2
KA-45-3	-	1/2	3	7/8	11/16	11/16	1/2
KA-45-4	-	1/2	4	7/8	11/16	11/16	1/2
KA-45-6	KD-45-6	1/2	6	7/8	11/16	11/16	1/2
KA-45-9	-	1/2	9	7/8	11/16	11/16	1/2
KA-104-9	-	1/2	9	1	3/4	3/4	9/16
-	KD-104-12	1/2	12	1	3/4	3/4	9/16
KA-105-3	KD-105-3	9/16	3	1	13/16	13/16	9/16
KA-105-4	-	9/16	4	1	13/16	13/16	9/16
KA-105-6	KD-105-6	9/16	6	1	13/16	13/16	9/16
KA-105-9	-	9/16	9	1	13/16	13/16	9/16
KA-205-3	-	5/8	3	1 1/8	7/8	7/8	19/32
-	KD-205-6	5/8	6	1 1/8	7/8	7/8	19/32

Universal wrenches must not be used with impact drivers. Maximum operating angle is 30°.

3/8" Sq. Dr. Socket Head Bits, SAE

Complete, Adapter Only, Insert Only

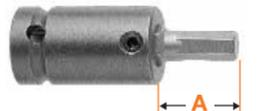

Part Number Complete	Part Number Adapter Only	Part Number Insert Only	Hex Size	Overall Length In.	Overall Length mm	Length of Insert (A) In.	Length of Insert (A) mm
SZ-10	SC-314	SZ-10-A	1/8	2 1/4	57	1 3/8	35
SZ-11	SC-314	SZ-11-A	5/32	2 1/4	57	1 3/8	35
SZ-12	SC-314	SZ-12-A	3/16	2 1/4	57	1 3/8	35
SZ-13	SC-314	SZ-13-A	7/32	2 1/4	57	1 3/8	35
SZ-14	SC-314	SZ-14-A	1/4	2 1/4	57	1 3/8	35
SZ-15	SC-314	SZ-15-A	5/16	2 1/4	57	1 3/8	35
SZ-16	SC-314	SZ-16-A	3/8	2 1/4	57	1 3/8	35

See page 35 for more 3/8" drive complete socket head bits.

3/8" Square Drive Sockets, Metric

6 Point & 12 Point, Short and Standard Length



Part Number 6 Point	Part Number 12 Point	Hex Opening mm	Overall Length (A)	Diameter Nose End (B)	Diameter Drive End (C)	Opening Depth (D)
6mm13	-	6	31.7	11.1	19.1	3.9
7mm03	-	7	22.2	11.1	19.1	3.0
7mm13	-	7	31.7	11.1	19.1	4.8
8mm03	-	8	22.2	12.7	19.1	4.8
8mm13	8mm13-D	8	31.7	12.7	19.1	4.8
OS-8mm13*	-	8	31.7	11.7	15.7	4.8
9mm13	9mm13-D	9	31.7	15.1	19.1	4.8
10mm03	10mm03-D	10	22.2	16.8	19.1	6.4
OS-10mm03*	-	10	22.1	15.7	15.7	6.4
10mm13	10mm13-D	10	31.7	16.8	19.1	6.4
11mm03	11mm03-D	11	22.2	17.5	19.1	7.2
11mm13	11mm13-D	11	31.7	17.5	19.1	7.2
12mm03	12mm03-D	12	22.2	19.1	19.1	7.2
12mm13	12mm13-D	12	38.1	19.1	19.1	7.2
13mm03	13mm03-D	13	22.2	20.6	20.6	7.9
13mm13	13mm13-D	13	38.1	20.6	20.6	8.7
14mm03	14mm03-D	14	22.2	22.2	22.2	7.9
14mm13	14mm13-D	14	38.1	22.2	22.2	11.1
15mm03	15mm03-D	15	23.8	22.2	22.2	9.5
15mm13	15mm13-D	15	38.1	22.2	22.2	11.1
16mm03	16mm03-D	16	25.4	23.8	23.8	11.1
16mm13	16mm13-D	16	38.1	23.8	23.8	11.1
17mm03	-	17	25.4	25.4	25.4	11.1
17mm13	17mm13-D	17	38.1	25.4	25.4	11.1
18mm03	-	18	25.4	25.4	25.4	11.1
18mm13	18mm13-D	18	38.1	25.4	25.4	11.1
19mm03	19mm03-D	19	25.4	28.6	28.6	11.1
19mm13	19mm13-D	19	38.1	28.6	28.6	11.9
20mm03	-	20	25.4	28.6	28.6	11.1
21mm03	-	21	25.4	31.7	31.7	11.1
21mm13	-	21	38.1	31.7	31.7	13.5
22mm03	-	22	25.4	31.7	31.7	11.1
22mm13	-	22	38.1	31.7	31.7	14.3

*No ring groove.

6 Point & Double Hex, Thin Wall, Standard Length



Part Number 6 Point	Part Number 12 Point	Hex Opening mm	Overall Length (A)	Diameter Nose End (B)	Diameter Drive End (C)	Opening Depth (D)
6mm43	-	6	31.7	9.5	19.1	3.9
7mm43	7mm43-D	7	31.7	11.1	19.1	4.8
8mm43	8mm43-D	8	31.7	12.7	19.1	4.8
9mm43	9mm43-D	9	31.7	12.7	19.1	4.8
10mm43	10mm43-D	10	31.7	15.1	19.1	6.4
11mm43	-	11	38.1	15.9	19.1	7.2
12mm43	12mm43-D	12	38.1	17.5	19.1	7.2
13mm43	13mm43-D	13	38.1	19.1	19.1	8.7
14mm43	14mm43-D	14	38.1	19.8	20.6	11.1
15mm43	15mm43-D	15	38.1	20.6	20.6	11.1
16mm43	16mm43-D	16	38.1	22.2	22.2	11.1
17mm43	17mm43-D	17	38.1	23.8	23.8	11.1
18mm43	-	18	38.1	23.8	23.8	11.1
19mm43	19mm43-D	19	38.1	25.4	25.4	11.9

6 Point & Double Hex, Long and Extra Long Length



Part Number 6 Point	Part Number 12 Point	Hex Opening mm	Overall Length (A)	Diameter Nose End (B)	Diameter Drive End (C)	Opening Depth (D)
7mm23	-	7	50.8	11.1	19.1	4.8
8mm23	8mm23-D	8	50.8	12.7	19.1	4.8
9mm23	9mm23-D	9	50.8	15.1	19.1	4.8
10mm23	10mm23-D	10	50.8	16.8	19.1	6.4
OS-10mm23*	OS-10mm23-D*	10	50.8	14.2	15.9	6.4
10mm33	-	10	88.9	16.8	19.1	6.4
11mm23	11mm23-D	11	50.8	17.5	19.1	7.2
12mm23	12mm23-D	12	50.8	19.1	19.1	7.2
13mm23	13mm23-D	13	50.8	20.6	20.6	8.7
13mm33	-	13	88.9	20.6	20.6	8.7
14mm23	14mm23-D	14	50.8	22.2	22.2	11.1
15mm23	15mm23-D	15	50.8	22.2	22.2	11.1
15mm33	15mm33-D	15	88.9	22.2	22.2	11.1
16mm23	16mm23-D	16	50.8	23.8	23.8	11.1
17mm23	17mm23-D	17	50.8	25.4	25.4	11.1
18mm23	18mm23-D	18	50.8	25.4	25.4	11.1
19mm23	19mm23-D	19	50.8	28.6	28.6	11.9
21mm23	-	21	50.8	31.7	31.7	13.5
22mm23	-	22	50.8	31.7	31.7	14.3

*No ring groove.

Magnetic, Short & Standard Length



Part Number Fixed Magnet	Hex Opening mm	Overall Length (A)	Diameter Nose End (B)	Diameter Drive End (C)	Opening Depth (D)
M-6mm13	6	31.8	11.1	19.1	3.9
M-7mm13	7	31.8	11.1	19.1	4.8
M-8mm13	8	31.8	12.7	19.1	4.8
M-9mm13	9	31.8	15.1	19.1	4.8
M-10mm03	10	22.2	16.8	19.1	6.4
M-10mm13	10	31.8	16.8	19.1	6.4
M-11mm03	11	22.2	17.5	19.1	7.2
M-11mm13	11	38.1	17.5	19.1	7.2
M-12mm03	12	22.2	19.1	19.1	7.2
M-12mm13	12	38.1	19.1	19.1	7.2
M-13mm03	13	22.2	20.6	20.6	8.7
M-13mm13	13	38.1	20.6	20.6	8.7
M-14mm13	14	38.1	22.2	22.2	11.1
M-15mm03	15	23.8	22.2	22.2	9.5
M-15mm13	15	38.1	22.2	22.2	11.1
M-16mm13	16	38.1	23.8	23.8	11.1
M-17mm13	17	38.1	25.4	25.4	11.1
M-18mm03	18	25.4	25.4	25.4	11.1
M-18mm13	18	38.1	25.4	25.4	11.1

BOLDED part numbers are industry popular items and are followed by common variations which may vary in price and availability.

3/8" Square Drive Sockets, Metric

Magnetic, Thin Wall, Standard Length



Part Number Fixed Magnet	Hex Opening mm	Overall Length (A)	Diameter Nose End (B)	Diameter Drive End (C)	Opening Depth (D)
M-8mm43	8	31.7	12.7	19.1	4.8
M-10mm43	10	31.7	15.1	19.1	6.4
M-11mm43	11	38.1	15.9	19.1	7.2
M-12mm43	12	38.1	17.5	19.1	7.2
M-13mm43	13	38.1	19.1	19.1	8.7
M-14mm43	14	38.1	19.8	20.6	11.1
M-15mm43	15	38.1	20.5	20.6	11.1

Magnetic, Long & Extra Long Length



Part Number Fixed Magnet	Hex Opening mm	Overall Length (A)	Diameter Nose End (B)	Diameter Drive End (C)	Opening Depth (D)
MB-6mm23	6	50.8	11.1	19.1	3.9
MB-7mm23	7	50.8	11.1	19.1	4.8
MB-8mm23	8	50.8	12.7	19.1	4.8
OSMB-8mm23*	8	50.8	11.7	15.9	4.8
MB-9mm23	9	50.8	15.1	19.1	4.8
OSMB-10mm23*	10	50.8	14.2	15.9	6.4
MB-10mm23	10	50.8	16.8	19.1	6.4
OSMB-10mm33*	10	88.9	16.8	19.1	6.4
MB-11mm23	11	50.8	17.5	19.1	7.2
MB-12mm23	12	50.8	19.1	19.1	7.2
MB-13mm23	13	50.8	20.6	20.6	8.7
MB-13mm33	13	88.9	20.6	20.6	8.7
MB-14mm23	14	50.8	22.2	22.2	11.1
MB-15mm23	15	50.8	22.2	22.2	11.1
MB-16mm23	16	50.8	23.8	23.8	11.1
MB-17mm23	17	50.8	25.4	25.4	11.1
MB-18mm23	18	50.8	25.4	25.4	11.1

*No ring groove.

Surface Drive, Short and Standard Length



Part Number Fixed Magnet	Hex Opening mm	Overall Length (A)	Diameter Nose End (B)	Diameter Drive End (C)	Opening Depth (D)
SF-8mm13	8	31.7	12.7	19.1	4.8
SF-10mm03	10	22.2	16.8	19.1	6.4
SF-10mm13	10	31.7	16.8	19.1	6.4
SF-11mm13	11	38.1	17.5	19.1	7.2
SF-12mm03	12	22.2	19.1	19.1	7.2
SF-12mm13	12	38.1	19.1	19.1	7.2
SF-13mm03	13	22.2	20.6	20.6	8.7
SF-13mm13	13	38.1	20.6	20.6	8.7
SF-14mm13	14	38.1	22.2	22.2	11.1
SF-15mm03	15	23.8	22.2	22.2	11.1
SF-15mm13	15	38.1	22.2	22.2	11.1
SF-16mm13	16	38.1	23.8	23.8	11.1
SF-17mm03	17	25.4	25.4	25.4	11.1
SF-17mm13	17	38.1	25.4	25.4	11.1
SF-18mm13	18	38.1	25.4	25.4	11.1
SF-19mm13	18	38.1	28.6	28.6	11.9



Surface Drive, Thin Wall, Standard Length



Part Number Surface Drive	Hex Opening mm	Overall Length (A)	Diameter Nose End (B)	Diameter Drive End (C)	Opening Depth (D)
SF-10mm43	10	31.7	15.1	19.1	6.4
OSSF-10mm43*	10	31.7	15.1	15.1	6.4
SF-11mm43	11	38.1	15.9	19.1	7.2
SF-12mm43	12	38.1	17.5	19.1	7.2
SF-13mm43	13	38.1	19.1	19.1	8.7
SF-15mm43	15	38.1	20.6	20.6	11.1
SF-17mm43	17	38.1	23.8	23.8	11.1
SF-18mm43	18	38.1	23.8	23.8	11.1
SF-19mm43	19	38.1	25.4	25.4	11.9

*No ring groove.

Surface Drive, Long & Extra Long Length

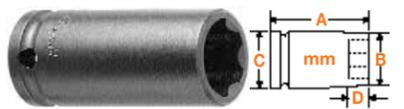

Part Number Surface Drive	Hex Opening mm	Overall Length (A)	Diameter Nose End (B)	Diameter Drive End (C)	Opening Depth (D)
SF-8mm23	8	50.8	12.7	19.1	4.8
OSSF-8mm23*	8	50.8	11.9	15.9	4.8
SF-10mm23	10	50.8	16.8	19.1	6.4
OSSF-10mm23*	10	50.8	14.2	15.9	6.4
SF-10mm33	10	88.9	16.8	19.1	6.4
SF-11mm23	11	50.8	17.5	19.1	7.2
SF-11mm33	12	50.8	19.1	19.1	7.2
SF-13mm23	13	50.8	20.6	20.6	8.7
SF-13mm33	13	88.9	20.6	20.6	8.7
SF-15mm23	15	50.8	22.2	22.2	11.1
SF-15mm33	15	88.9	22.2	22.2	11.1
SF-17mm23	17	50.8	25.4	25.4	11.1
SF-18mm23	18	50.8	25.4	25.4	11.1
SF-19mm23	19	50.8	28.6	28.6	11.9

*No ring groove.

3/8" Sq. Dr. Sockets For Metric Sheet Metal Screws

6 Point & 6 Point Magnetic, for Predrilled Holes



Part Number 6 Point	Part Number Magnetic	Hex Opening mm	Overall Length (A)	Diameter Nose End (B)	Diameter Drive End (C)	Opening Depth (D)
-	M-6mmE3	6	31.7	11.1	19.1	3.9
-	M-7mmE3	7	31.7	11.9	19.1	4.8
8mmE3	M-8mmE3	8	31.7	12.7	19.1	4.8
10mmE3	M-10mmE3	10	31.7	16.8	19.1	6.4</

3/8" Sq. Dr. Socket Sets, Metric

6 Point



APS312M	12 piece, standard length: 7mm, 8mm, 9mm, 10mm, 11mm, 12mm, 13mm, 14mm, 15mm, 16mm, 17mm, 18mm
APS312LM	12 piece, long length: 7mm, 8mm, 9mm, 10mm, 11mm, 12mm, 13mm, 14mm, 15mm, 16mm, 17mm, 18mm

Universal Wrenches 3/8" Sq. Dr., Metric

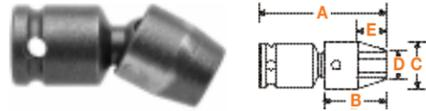

6 Point

Part Number	Hex Opening	Overall Length	Socket Length	Socket Diameter	Nose End Diameter	Clearance Depth
6 Point	mm	(A) mm	(B) mm	(C) mm	(D) mm	(E) mm
SA-36-10m	10	48	20.6	19.1	15.1	9.5
SA-37-12m	12	51	23.8	22.2	17.5	10.3
SA-37-13m	13	52	25.4	22.2	17.5	11.9
SA-37-14m	14	54	27.0	22.2	19.1	13.5
SA-38-15m	15	56	28.6	25.4	19.8	14.3
SA-38-17m	17	59	31.8	25.4	25.4	17.5
SA-38-18m	18	59	31.8	25.4	25.4	17.5

Universal wrenches must not be used with impact drivers. Maximum operating angle is 30°.

3/8" Sq. Dr. Universal Wrench Set, Metric



6 Point

APU37M	7 piece, standard length: 10mm, 12mm, 13mm, 14mm, 15mm, 17mm, 18mm
---------------	---

3/8" Sq. Dr. Universal Wrenches, Metric - Extension

6 Point Standard and Tension Type



Part Number	Part Number	Hex Opening	Shank Length	Socket Length	Socket Diameter	Nose End Diameter	Clearance Depth
Standard	Tension	mm	(A) mm	(B) mm	(C) mm	(D) mm	(E) mm
KA-6-10m-4	-	10	102	20.6	19.1	15.1	9.5
KA-6-10m-6	KD-6-10m-6	10	152	20.6	19.1	15.1	9.5
KA-6-10m-9	KD-6-10m-9	10	229	20.6	19.1	15.1	9.5
-	KD-6-10m-12	10	305	20.6	19.1	15.1	9.5
-	KD-7-11m-6	11	152	23.8	22.2	15.9	10.3
KA-7-11m-12	KD-7-11m-12	11	305	23.8	22.2	15.9	10.3
KA-7-12m-4	-	12	102	23.8	22.2	17.5	10.3
KA-7-12m-6	KD-7-12m-6	12	152	23.8	22.2	17.5	10.3
KA-7-12m-9	KD-7-12m-9	12	229	23.8	22.2	17.5	10.3
KA-7-12m-12	KD-7-12m-12	12	305	23.8	22.2	17.5	10.3
KA-7-13m-3	-	13	76	25.4	22.2	17.5	11.9
KA-7-13m-4	-	13	102	25.4	22.2	17.5	11.9
KA-7-13m-6	KD-7-13m-6	13	152	25.4	22.2	17.5	11.9
KA-7-13m-9	KD-7-13m-9	13	229	25.4	22.2	17.5	11.9
KA-7-13m-12	KD-7-13m-12	13	305	25.4	22.2	17.5	11.9
KA-7-14m-6	KD-7-14m-6	14	152	27.0	22.2	19.1	13.5
-	KD-7-14m-9	14	229	27.0	22.2	19.1	13.5
KA-8-15m-3	-	15	76	28.6	25.4	19.8	14.3
-	KD-8-15m-6	15	152	28.6	25.4	19.8	14.3
KA-8-15m-9	KD-8-15m-9	15	229	28.6	25.4	19.8	14.3
KA-8-15m-12	KD-8-15m-12	15	305	28.6	25.4	19.8	14.3

Universal wrenches must not be used with impact drivers. Maximum operating angle is 30°.

3/8" Sq. Dr. Socket Head Bits, Metric

Complete, Adapter Only, Insert Only

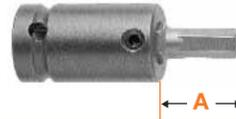

Part Number			Hex Size	Overall Length	Length of Insert (A)
Complete	Adapter Only	Insert Only		In. mm	In. mm
SZ-3-7-4mm	SC-314	SZ-7-4mm	4mm	2 1/4 57	1 3/8 35
SZ-3-7-5mm	SC-314	SZ-7-5mm	5mm	2 1/4 57	1 3/8 35
SZ-3-7-6mm	SC-314	SZ-7-6mm	6mm	2 1/4 57	1 3/8 35
SZ-3-7-8mm	SC-314	SZ-7-8mm	8mm	2 1/4 57	1 3/8 35
SZ-3-7-10mm	SC-314	SZ-7-10mm	10mm	2 1/4 57	1 3/8 35

See page 19 for more 3/8" drive complete socket head bits.

3/8" Sq. Dr. Sockets For Spline Fasteners

Standard and Long Length

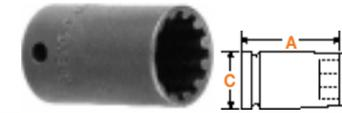

Part Number	Spline Size	Nominal Size	Overall Length (A)		Diameter Nose End (B)		Diameter Drive End (C)	
			In.	mm	In.	mm	In.	mm
CMS-3412	12	3/8	1	25	17/32	14	21/32	17
CMS-3512	12	3/8	2 1/8	54	17/32	14	21/32	17
CMS-3414	14	7/16	1 1/16	27	5/8	16	11/16	18
CMS-3416	16	1/2	1 1/16	27	23/32	18	23/32	18
CMS-3418	18	9/16	1 1/16	27	13/16	21	13/16	21
CMS-3518	18	9/16	2 3/8	60	13/16	21	13/16	21
CMS-3420	20	5/8	1 3/16	30	7/8	22	7/8	22

Apex spline sockets conform to military specifications MS-37787 and MIL-W-8982C.

3/8" Sq. Dr. Torx® Sockets



For External Torx Screws

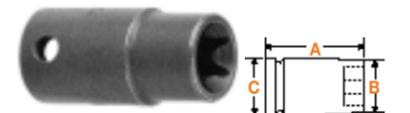

Part Number	Driver Size	Overall Length (A)		Nose End Diameter (B)		Drive End Diameter (C)	
		In.	mm	In.	mm	In.	mm
TX-3106	E-6	1 1/4	32	3/8	10	3/4	19
TX-3107	E-7	1 1/4	32	3/8	10	3/4	19
TX-3108	E-8	1 1/4	32	7/16	11	3/4	19
TX-3110	E-10	1 1/4	32	1/2	13	3/4	19
TX-3112	E-12	1 1/4	32	5/8	16	3/4	19
TX-3114	E-14	1 1/4	32	11/16	18	3/4	19
TX-3116	E-16	1 1/4	32	13/16	21	13/16	21

For External Torx Screws, Thin Wall



Part Number	Driver Size	Overall Length (A)		Nose End Diameter (B)		Drive End Diameter (C)	
		In.	mm	In.	mm	In.	mm
TX-3406	E-6	1 1/4	32	5/16	8	5/8	16
TX-3407	E-7	1 1/4	32	11/32	9	5/8	16
TX-3408	E-8	1 1/4	32	3/8	10	5/8	16
TX-3508	E-8	2	51	3/8	10	5/8	16
TX-3410	E-10	1 1/4	32	1/2	13	5/8	16
TX-3412	E-12	1 1/4	32	9/16	14	5/8	16
TX-3414	E-14	1 1/4	32	5/8	16	3/4	19

Some Torx® sockets have a DIN (pin and o-ring) groove.

For Torx Nuts



Part Number	Driver Size	Overall Length (A)		Nose End Diameter (B)		Drive End Diameter (C)	
		In.	mm	In.	mm	In.	mm
TX-3E08	E-8	1 1/4	32	5/8	16	5/8	16
TX-3E10	E-10	1 1/4	32	5/8	16	5/8	16

Sockets for Torx® nuts have a larger lead-in chamfer than sockets for external Torx® screws. Most Torx® sockets have a DIN (pin and o-ring) groove.

3/8" Sq. Dr. Extensions

1 1/4" to 18"
(32mm to 457mm)
Length



Part Number	Male Square In.	Type of Lock	Overall Length In.	Overall Length mm
EX-374	3/8	Pin	1 3/8	34
EX-374-B	3/8	Ball	1 3/8	34
EX-376-2	3/8	Pin	2	51
EX-376-B-2	3/8	Ball	2	51
EX-376-3	3/8	Pin	3	76
EX-376-B-3	3/8	Ball	3	76
EX-376-4	3/8	Pin	4	102
EX-376-B-4	3/8	Ball	4	102
EX-376-5	3/8	Pin	5	127
EX-376-B-5	3/8	Ball	5	127
EX-376-6	3/8	Pin	6	152
EX-376-B-6	3/8	Ball	6	152
EX-376-8	3/8	Pin	8	203
EX-376-B-8	3/8	Ball	8	203
EX-376-9	3/8	Pin	9	229
EX-376-B-9	3/8	Ball	9	229
EX-376-10	3/8	Pin	10	254
EX-376-B-10	3/8	Ball	10	254
EX-376-12	3/8	Pin	12	305
EX-376-B-12	3/8	Ball	12	305
EX-376-15	3/8	Pin	15	381
EX-376-B-15	3/8	Ball	15	381
EX-376-18	3/8	Pin	18	457

3/8" Sq. Dr. Adapters

1/4" to 3/4"
Male Square



Part Number	Male Square In.	Female Square In.	Type of Lock	Overall Length In.	Overall Length mm
EX-254	1/4	3/8	Pin	1 1/4	32
EX-254-B	1/4	3/8	Ball	1 1/4	32
EX-257-2	1/4	3/8	Pin	2	51
EX-257-B-2	1/4	3/8	Ball	2	51
EX-257-3	1/4	3/8	Pin	3	76
EX-257-B-3	1/4	3/8	Ball	3	76
EX-257-4	1/4	3/8	Pin	4	102
EX-257-B-4	1/4	3/8	Ball	4	102
EX-257-5	1/4	3/8	Pin	5	127
EX-257-B-5	1/4	3/8	Ball	5	127
EX-257-6	1/4	3/8	Pin	6	152
EX-257-B-6	1/4	3/8	Ball	6	152
EX-503	1/2	3/8	Pin	1 1/2	38
EX-503-B	1/2	3/8	Ball	1 1/2	38
EX-507-2	1/2	3/8	Pin	2	51
EX-507-3	1/2	3/8	Pin	3	76
EX-507-B-3	1/2	3/8	Ball	3	76
EX-507-4	1/2	3/8	Pin	4	102
EX-507-B-4	1/2	3/8	Ball	4	102
EX-507-6	1/2	3/8	Pin	6	152
EX-507-B-6	1/2	3/8	Ball	6	152
EX-622	5/8	3/8	Pin	1 1/2	38
EX-750	3/4	3/8	7/32 Drill Hole	1 1/2	38
EX-750-B	3/4	3/8	Ball	1 1/2	38

3/8" Sq. Dr. Universal Adapters

Male Square to Female Square



Part Number	Male Sq. In.	Female Sq. In.	Type of Lock	Overall Length In.	Overall Length mm	Largest Diameter In.	Largest Diameter mm
MF-27	1/4	3/8	Pin	1 5/16	49	3/4	19
MF-27B	1/4	3/8	Ball	1 5/16	49	3/4	19
MF-37	3/8	3/8	Pin	2 1/8	54	3/4	19
MF-37B	3/8	3/8	Ball	2 1/8	54	3/4	19
MF-38B	3/8	3/8	Ball	2 1/2	64	7/8	22

Universal wrenches must not be used with impact drivers.
Maximum operating angle is 30°.

3/8" Sq. Dr. Universal Adapters - Extension



(Standard Type Shown)

Male Square to Female Square

Standard	Part Number	Male Square In.	Female Square In.	Type of Lock	Largest Diameter In.	Largest Diameter mm
	KAM-37-3	3/8	3/8	Pin	3/4	19
-	KDM-37-6	3/8	3/8	Pin	3/4	19
-	KDM-37-B-3	3/8	3/8	Ball	3/4	19
KAM-38-6	KDM-38-6	3/8	3/8	Pin	7/8	22

Standard lengths are 3", 6", 9" and 12" (76, 152, 229 and 305mm)

BOLDED part numbers are industry popular items and are followed by common variations which may vary in price and availability.

1/2" Square Drive Sockets, SAE

6 Point and Double Hex, Standard Length

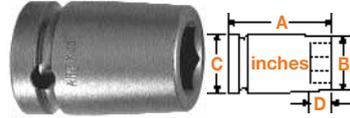

Part Number 6 Point	Part Number Double Hex	Hex Opening In.	Overall Length (A)	Diameter Nose End (B)	Diameter Drive End (C)	Opening Depth (D)
5108	-	1/4	1 1/2	7/16	15/16	5/32
5110	5110-D	5/16	1 1/2	1/2	15/16	3/16
5112	5112-D	3/8	1 1/2	5/8	15/16	1/4
5114	5114-D	7/16	1 1/2	11/16	15/16	9/32
5116	5116-D	1/2	1 1/2	13/16	15/16	11/32
SH-335	-	1/2	1 1/2	45/64	15/16	11/32
5118	5118-D	9/16	1 1/2	7/8	15/16	7/16
SH-336	SH-336-D	9/16	1 1/2	27/32	15/16	7/16
5119	-	19/32	1 1/2	15/16	15/16	7/16
5120	5120-D	5/8	1 1/2	1	1	7/16
SH-338	SH-338-D	5/8	1 1/2	15/16	1	7/16
5122	5122-D	11/16	1 1/2	1 1/8	1 1/8	7/16
SH-339	-	11/16	1 1/2	1 1/64	1 1/16	7/16
SW-282	SW-282-D	3/4	1 1/2	1 1/4	1 1/4	15/32
5124	5124-D	3/4	1 1/2	1 1/8	1 1/8	15/32
5126	5126-D	13/16	1 1/2	1 1/4	1 1/4	17/32
5128	5128-D	7/8	1 1/2	1 5/16	1 5/16	9/16
5130	5130-D	15/16	1 1/2	1 3/8	1 3/8	5/8
5131	-	31/32	1 1/2	1 1/2	1 1/2	5/8
5132	5132-D	1	1 1/2	1 1/2	1 1/2	5/8
5134	5134-D	1 1/16	1 5/8	1 1/2	1 1/2	11/16
5136	5136-D	1 1/8	1 5/8	1 5/8	1 5/8	3/4
5138	5138-D	1 3/16	1 5/8	1 3/4	1 3/4	3/4
5140	5140-D	1 1/4	1 3/4	1 3/4	1 3/4	13/16
5142	-	1 5/16	1 3/4	1 7/8	1 7/8	13/16
5144	5144-D	1 3/8	1 7/8	2	2	13/16
5146	-	1 7/16	2	2	2	15/16
5148	5148-D	1 1/2	2	2 1/8	2 1/8	1
5152	5152-D	1 5/8	2	2 3/8	2 3/8	1 1/8
5154	-	1 11/16	2	2 3/8	2 3/8	1 1/8
5156	-	1 3/4	2	2 1/2	2 1/2	1 1/8

6 Point and Double Hex, Thin Wall, Standard Length



Part Number 6 Point	Part Number Double Hex	Hex Opening In.	Overall Length (A)	Diameter Nose End (B)	Diameter Drive End (C)	Opening Depth (D)
5412	5412-D	3/8	1 1/2	19/32	15/16	1/4
5414	5414-D	7/16	1 1/2	21/32	15/16	9/32
5416	5416-D	1/2	1 1/2	23/32	15/16	11/32
5418	5418-D	9/16	1 1/2	13/16	15/16	7/16
5420	5420-D	5/8	1 1/2	7/8	15/16	7/16
5421	5421-D	21/32	1 1/2	29/32	15/16	7/16
*5422	*5422-D	11/16	1 1/2	15/16	15/16	7/16
OS-5424**	-	3/4	1 1/2	1 1/32	1 1/32	15/32
5424	5424-D	3/4	1 1/2	1 1/32	1 1/8	15/32
5426	5426-D	13/16	1 1/2	1 1/8	1 1/8	17/32
HE-1028	HE-1028-D	7/8	1 1/2	1 1/4	1 1/4	9/16
*5428	-	7/8	1 1/2	1 3/16	1 1/4	9/16
HE-530	-	15/16	1 1/2	1 5/16	1 5/16	5/8

* Extra thin wall
** No ring groove

Continued on next column.

6 Point and Double Hex, Thin Wall, Standard Length



Continued from previous column.

Part Number 6 Point	Part Number Double Hex	Hex Opening In.	Overall Length (A)	Diameter Nose End (B)	Diameter Drive End (C)	Opening Depth (D)
*5430	*5430-D	15/16	1 1/2	1 1/4	1 1/4	5/8
5432	5432-D	1	1 1/2	1 3/8	1 3/8	5/8
5434	5434-D	1 1/16	1 5/8	1 7/16	1 7/16	11/16
5436	5436-D	1 1/8	1 5/8	1 1/2	1 1/2	3/4
5438	-	1 3/16	1 5/8	1 5/8	1 5/8	3/4
5440	5440-D	1 1/4	1 3/4	1 11/16	1 3/4	13/16
5442	-	1 5/16	1 3/4	1 25/32	1 7/8	13/16

* Extra thin wall
** No ring groove

6 Point and Double Hex, Long & Extra Long Length



Part Number 6 Point	Part Number Double Hex	Hex Opening In.	Overall Length (A)	Diameter Nose End (B)	Diameter Drive End (C)	Opening Depth (D)
5210	-	5/16	2 1/4	1/2	15/16	3/16
5310	-	5/16	3 1/4	1/2	15/16	3/16
5212	-	3/8	2 1/4	5/8	15/16	1/4
5312	-	3/8	3 1/4	5/8	15/16	1/4
5214	-	7/16	2 1/4	11/16	15/16	9/32
5314	-	7/16	3 1/4	11/16	15/16	9/32
5216	5216-D	1/2	2 1/4	13/16	15/16	11/32
5316	5316-D	1/2	3 1/4	13/16	15/16	11/32
5218	5218-D	9/16	2 1/4	7/8	15/16	7/16
5318	5318-D	9/16	3 1/4	7/8	15/16	7/16
5220	-	5/8	2 1/4	1	1	7/16
5320	-	5/8	3 1/4	1	1	7/16
5222	-	11/16	2 1/4	1 1/8	1 1/8	7/16
5322	5322-D	11/16	3 1/4	1 1/8	1 1/8	7/16
5224	5224-D	3/4	2 1/4	1 1/8	1 1/8	15/32
5324	5324-D	3/4	3 1/4	1 1/8	1 1/8	15/32
SW-493	-	3/4	2 1/4	1 1/4	1 1/4	15/32
5226	5226-D	13/16	2 1/4	1 1/4	1 1/4	17/32
5326	-	13/16	3 1/2	1 1/4	1 1/4	17/32
5228	5228-D	7/8	2 1/4	1 5/16	1 5/16	9/16
5328	-	7/8	3 1/2	1 5/16	1 5/16	9/16
5230	5230-D	15/16	2 1/4	1 3/8	1 3/8	5/8
5330	5330-D	15/16	3 1/2	1 3/8	1 3/8	5/8
5232	-	1	2 1/4	1 1/2	1 1/2	5/8
5332	-	1	3 1/2	1 1/2	1 1/2	5/8
5234	-	1 1/16	2 3/8	1 1/2	1 1/2	11/16
5334	-	1 1/16	3 1/2	1 1/2	1 1/2	11/16
5236	5236-D	1 1/8	2 3/8	1 5/8	1 5/8	3/4
5336	5336-D	1 1/8	3 1/2	1 5/8	1 5/8	3/4
5238	-	1 3/16	2 3/8	1 3/4	1 3/4	3/4
5338	-	1 3/16	3 1/2	1 3/4	1 3/4	3/4
5240	5240-D	1 1/4	2 1/2	1 3/4	1 3/4	13/16
5340	5340-D	1 1/4	3 1/2	1 3/4	1 3/4	13/16
5242	-	1 5/16	2 1/2	1 7/8	1 7/8	13/16
5342	-	1 5/16	3 1/2	1 7/8	1 7/8	13/16
5244	-	1 3/8	2 1/2	2	2	13/16
5344	-	1 3/8	3 5/8	2	2	13/16
5248	-	1 1/2	2 1/2	2 1/8	2 1/8	1
5348	-	1 1/2	3 3/4	2 1/8	2 1/8	1

BOLD part numbers are industry popular items and are followed by common variations which may vary in price and availability.

1/2" Square Drive Sockets, SAE

6 Point and Double Hex, Thin Wall, Extra Long Length



Part Number 6 Point	Part Number Double Hex	Hex Opening In.	Overall Length (A)	Diameter Nose End (B)	Diameter Drive End (C)	Opening Depth (D)
5510	-	5/16	3 1/4	1/2	15/16	3/16
5512	5512-D	3/8	3 1/4	19/32	15/16	1/4
5514	5514-D	7/16	3 1/4	21/32	15/16	9/32
5516	5516-D	1/2	3 1/4	23/32	15/16	11/32
OS-5516*	-	1/2	3 1/4	47/64	7/8	11/32
5518	5518-D	9/16	3 1/4	13/16	15/16	7/16
OS-5518*	-	9/16	3 1/4	13/16	27/32	7/16
5520	5520-D	5/8	3 1/4	7/8	15/16	7/16
5522	5522-D	11/16	3 1/4	15/16	15/16	7/16
5524	5524-D	3/4	3 1/4	1 1/32	1 1/8	15/32
5526	5526-D	13/16	3 1/2	1 1/8	1 1/8	17/32
5528	5528-D	7/8	3 1/2	1 3/16	1 1/4	9/16
5530	5530-D	15/16	3 1/2	1 1/4	1 1/4	5/8
5532	5532-D	1	3 1/2	1 3/8	1 3/8	5/8
5534	5534-D	1 1/16	3 1/2	1 7/16	1 7/16	11/16

* No ring groove.

Magnetic, Standard Length



Part Number Fixed Magnet	Hex Opening In.	Overall Length (A)	Diameter Nose End (B)	Diameter Drive End (C)	Opening Depth (D)
M-5110	5/16	1 1/2	1/2	15/16	3/16
M-5112	3/8	1 1/2	5/8	15/16	1/4
M-5114	7/16	1 1/2	11/16	15/16	9/32
M-5116	1/2	1 1/2	13/16	15/16	11/32
MSH-335	1/2	1 1/2	45/64	15/16	11/32
M-5118	9/16	1 1/2	7/8	15/16	7/16
MSH-336	9/16	1 1/2	27/32	15/16	7/16
M-5120	5/8	1 1/2	1	1	7/16
M-5122	11/16	1 1/2	1 1/8	1 1/8	7/16
M-5124	3/4	1 1/2	1 1/8	1 1/8	15/32

Magnetic, Thin Wall, Standard Length



Part Number Fixed Magnet	Hex Opening In.	Overall Length (A)	Diameter Nose End (B)	Diameter Drive End (C)	Opening Depth (D)
M-5416	1/2	1 1/2	23/32	15/16	11/32
M-5418	9/16	1 1/2	13/16	15/16	7/16
M-5420	5/8	1 1/2	7/8	15/16	7/16

Magnetic, Long Length & Extra Long Length



Part Number 6 Point	Part No. Magnetic Bolt Clearance	Hex Opening In.	Overall Length (A)	Diameter Nose End (B)	Diameter Drive End (C)	Opening Depth (D)
-	MB-5212	3/8	2 1/4	5/8	15/16	1/4
M-5512*	-	3/8	3 1/4	19/32	15/16	1/4
-	MB-5214	7/16	2 1/4	11/16	15/16	9/32
M-5216	MB-5216	1/2	2 1/4	13/16	15/16	11/32
M-5316	-	1/2	3 1/4	13/16	15/16	11/32
M-5218	-	9/16	2 1/4	7/8	15/16	7/16
-	MB-HE9518	9/16	2 1/4	7/8	15/16	7/16
M-5518*	-	9/16	3 1/4	13/16	15/16	7/16
-	MB-5220	5/8	2 1/4	1	1	7/16

* Thin Wall

Surface Drive & Fast Lead, Standard Length

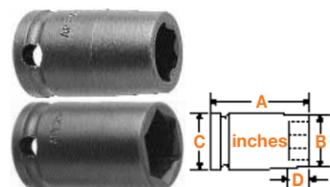

Part Number 6 Point	Part Number Fast Lead	Hex Opening In.	Overall Length (A)	Diameter Nose End (B)	Diameter Drive End (C)	Opening Depth (D)
SF-5112	-	3/8	1 1/2	5/8	15/16	1/4
-	FL-5114	7/16	1 1/2	11/16	15/16	9/32
SF-5116	FL-5116	1/2	1 1/2	13/16	15/16	11/32
SF-SH-335	FL-SH-335	1/2	1 1/2	45/64	15/16	11/32
SF-5118	FL-5118	9/16	1 1/2	7/8	15/16	7/16
SF-SH-336	-	9/16	1 1/2	27/32	15/16	7/16
SF-5120	FL-5120	5/8	1 1/2	1	1	7/16
SF-5122	FL-5122	11/16	1 1/2	1 1/8	1 1/8	7/16
SF-5124	FL-5124	3/4	1 1/2	1 1/8	1 1/8	15/32
SF-SW-282	-	3/4	1 1/2	1 1/4	1 1/4	15/32
SF-5126	FL-5126	13/16	1 1/2	1 1/4	1 1/4	17/32
SF-5128	FL-5128	7/8	1 1/2	1 5/16	1 5/16	9/16
SF-5130	FL-5130	15/16	1 1/2	1 3/8	1 3/8	5/8
SF-5132	FL-5132	1	1 1/2	1 1/2	1 1/2	5/8
SF-5134	FL-5134	1 1/16	1 5/8	1 1/2	1 1/2	11/16

Surface Drive & Fast Lead, Thin Wall, Standard Length

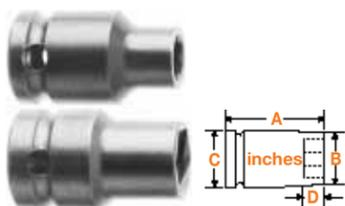

Part Number 6 Point	Part Number Fast Lead	Hex Opening In.	Overall Length (A)	Diameter Nose End (B)	Diameter Drive End (C)	Opening Depth (D)
SF-5412	-	3/8	1 1/2	19/32	15/16	1/4
SF-5414	-	7/16	1 1/2	21/32	15/16	9/32
SF-5416	FL-5416	1/2	1 1/2	23/32	15/16	11/32
SF-5418	FL-5418	9/16	1 1/2	13/16	15/16	7/16
SF-5420	-	5/8	1 1/2	7/8	15/16	7/16
SF-5422	-	11/16	1 1/2	15/16	15/16	7/16
SF-5424	-	3/4	1 1/2	1 1/32	1 1/8	15/32
SF-5426	-	13/16	1 1/2	1 1/8	1 1/8	17/32

BOLDED part numbers are industry popular items and are followed by common variations which may vary in price and availability.

1/2" Sq. Dr. Sockets, SAE

Surface Drive & Fast Lead, Long and Extra Long Length



Part Number 6 Point	Part Number Fast Lead	Hex Opening In.	Overall Length (A)	Diameter Nose End (B)	Diameter Drive End (C)	Opening Depth (D)
SF-5212	-	3/8	2 1/4	9/16	15/16	9/32
SF-5216	FL-5216	1/2	2 1/4	13/16	15/16	11/32
-	FL-5316	1/2	3 1/4	13/16	15/16	11/32
SF-HE9518	FL-HE9518	9/16	2 1/4	7/8	7/8	7/16
SF-5218	FL-5218	9/16	2 1/4	7/8	15/16	7/16
SF-5318	FL-5318	9/16	3 1/4	7/8	15/16	7/16
SF-5320	FL-5320	5/8	3 1/4	1	1	7/16
SF-5222	FL-5222	11/16	2 1/4	1 1/8	1 1/8	7/16
SF-5224	FL-5224	3/4	2 1/4	1 1/8	1 1/8	15/32
-	FL-SW-493	3/4	2 1/4	1 1/4	1 1/4	15/32
SF-5324	FL-5324	3/4	3 1/4	1 1/8	1 1/8	15/32
SF-5226	FL-5226	13/16	2 1/4	1 1/4	1 1/4	17/32
-	FL-5326	13/16	3 1/2	1 1/4	1 1/4	17/32
SF-5228	FL-5228	7/8	2 1/4	1 5/16	1 5/16	9/16
SF-5328	-	7/8	3 1/2	1 5/16	1 5/16	9/16
SF-5230	-	15/16	2 1/4	1 3/8	1 3/8	5/8
SF-5330	-	15/16	3 1/2	1 3/8	1 3/8	5/8
SF-5232	-	1	2 1/4	1 1/2	1 1/2	5/8

Surface Drive, Thin Wall, Extra Long Length



Part Number Surface Drive	Hex Opening In.	Overall Length (A)	Diameter Nose End (B)	Diameter Drive End (C)	Opening Depth (D)
SF-5514	7/16	3 1/4	21/32	15/16	9/32
SF-5516	1/2	3 1/4	23/32	15/16	11/32
SF-5518	9/16	3 1/4	13/16	15/16	7/16
SF-5520	5/8	3 1/4	7/8	15/16	7/16
SF-5524	3/4	3 1/4	1 1/32	1 1/8	15/32
SF-5526	13/16	3 1/4	1 1/8	1 1/8	17/32
SF-5528	7/8	3 1/2	1 3/16	1 1/4	9/16
SF-5532	1	3 1/2	1 3/8	1 3/8	5/8

BOLDED part numbers are industry popular items and are followed by common variations which may vary in price and availability.

1/2" Sq. Dr. Sockets For SAE Sheet Metal Screws

6 Point & 6 Point Magnetic, for Predrilled Holes*



Part Number 6 Point	Part Number Magnetic	Hex Opening In.	Overall Length (A)	Diameter Nose End (B)	Diameter Drive End (C)	Opening Depth (D)
5E10	M5E10	5/16	1 1/2	1/2	15/16	3/16
5E12	M5E12	3/8	1 1/2	5/8	15/16	1/4
-	M5E14	7/16	1 1/2	11/16	15/16	9/32
5E16	M5E16	1/2	1 1/2	13/16	15/16	11/32
-	M5E18	9/16	1 1/2	15/16	15/16	7/16

6 Point & 6 Point Magnetic, for Self-Tapping Screws*



Part Number 6 Point	Part Number Magnetic	Hex Opening In.	Overall Length (A)	Diameter Nose End (B)	Diameter Drive End (C)	Opening Depth (D)
-	M5P10	5/16	1 1/2	1/2	15/16	3/16
5P12	M5P12	3/8	1 1/2	5/8	15/16	1/4
5P14	M5P14	7/16	1 1/2	11/16	15/16	9/32
-	M5P16	1/2	1 1/2	13/16	15/16	11/32
-	M5P18	9/16	1 1/2	15/16	15/16	7/16

*Sockets for predrilled holes are intermediate hardness; sockets for self-tapping screws are maximum hardness.

If the tool you need does not appear in this catalog, give us a call. The odds are, we may have what you need as a non-catalog item. If not, our experienced staff of tooling experts can design and manufacture "specials" to meet the needs of your specific application. Give us a call at 1-800-845-5629 or visit our website www.apex-tools.com.

1/2" Sq. Dr. Sockets For SAE Square Nuts

Single Square & Double Square, Standard Length



Part Number 6 Point	Part Number Double Square	Square Opening In.	Overall Length (A)	Diameter Nose End (B)	Diameter Drive End (C)	Opening Depth (D)
5609	-	9/32	1 1/2	1/2	15/16	3/16
5610	5610-D	5/16	1 1/2	5/8	15/16	1/4
5612	5612-D	3/8	1 1/2	3/4	15/16	1/4
5614	5614-D	7/16	1 1/2	7/8	15/16	9/32
5616	5616-D	1/2	1 1/2	1	1	11/32
5618	5618-D	9/16	1 1/2	1 1/8	1 1/8	7/16
5620	5620-D	5/8	1 1/2	1 1/4	1 1/4	7/16
5622	-	11/16	1 1/2	1 1/4	1 1/4	7/16
5624	5624-D	3/4	1 1/2	1 3/8	1 3/8	15/32
5626	-	13/16	1 1/2	1 1/2	1 1/2	17/32
5628	-	7/8	1 1/2	1 5/8	1 5/8	5/8
5632	-	1	1 5/8	1 3/4	1 3/4	5/8
5634	-	1 1/16	1 3/4	1 7/8	1 7/8	11/16
5636	5636-D	1 1/8	1 3/4	2	2	3/4

Single Square & Double Square, Thin Wall, Standard Length



Part Number Square	Part Number Double Square	Square Opening In.	Overall Length (A)	Diameter Nose End (B)	Diameter Drive End (C)	Opening Depth (D)
5912	5912-D	3/8	1 1/2	11/16	15/16	1/4
5914	5914-D	7/16	1 1/2	25/32	15/16	9/32
5918	5918-D	9/16	1 1/2	1	1	7/16
5920	-	5/8	1 1/2	1 3/32	1 1/8	7/16

Single Square & Double Square, Long & Extra Long Length



Part Number Square	Part Number Double Square	Square Opening In.	Overall Length (A)	Diameter Nose End (B)	Diameter Drive End (C)	Opening Depth (D)
5812	-	3/8	3 1/4	3/4	15/16	1/4
5716	-	1/2	2 1/4	1	1	11/32
-	5816-D	1/2	3 1/4	1	1	7/16
5720	-	5/8	2 1/4	1 1/4	1 1/4	7/16
5820	5820-D	5/8	3 1/2	1 1/4	1 1/4	7/16
5822	5822-D	11/16	3 1/2	1 1/4	1 1/4	7/16
5724	5724-D	3/4	2 1/4	1 3/8	1 3/8	15/32
-	5826-D	13/16	3 1/2	1 1/2	1 1/2	17/32
5728	-	7/8	2 1/4	1 5/8	1 5/8	5/8
-	5832-D	1	3 1/2	1 3/4	1 3/4	5/8
-	5834-D	1 1/16	3 1/2	1 7/8	1 7/8	11/16
-	5836-D	1 1/8	3 1/2	2	2	3/4

BOLDED part numbers are industry popular items and are followed by common variations which may vary in price and availability.

1/2" Sq. Dr. Socket Sets, SAE

6 Point



APS58XL	8 piece, extra long length: 1/2, 9/16, 5/8, 11/16, 3/4, 13/16, 7/8, 15/16
---------	--

Universal Wrenches 1/2" Sq. Dr., SAE



6 Point & Double Hex

Part Number 6 Point	Part Number 12 Point	Hex Opening In.	Overall Length (A) In.	Socket Length (B) In.	Socket Diameter (C) In.	Nose End Diameter (D) In.	Clearance Depth (E) In.
SA-120	SA-120-D	5/16	1 53/64	3/4	3/4	7/16	5/16
SA-216	SA-216-D	3/8	2 11/64	7/8	7/8	9/16	11/32
SA-217	SA-217-D	7/16	2 15/64	15/16	7/8	5/8	13/32
SA-316	-	7/16	2 17/64	15/16	1	5/8	3/8
SA-218	SA-218-D	1/2	2 19/64	1	7/8	11/16	15/32
SA-317	-	1/2	2 31/64	1	1	11/16	7/16
SA-219	SA-219-D	9/16	2 23/64	1 1/16	7/8	3/4	17/32
SA-318	SA-318-D	9/16	2 29/64	1 1/8	1	3/4	9/16
SA-221	SA-221-D	5/8	2 27/64	1 1/8	7/8	7/8	19/32
SA-320	-	5/8	2 33/64	1 3/16	1	27/32	5/8
SA-402	SA-402-D	5/8	2 49/64	1 1/4	1 1/4	7/8	33/64
SA-321	SA-321-D	11/16	2 37/64	1 1/4	1	1	11/16
SA-322	SA-322-D	3/4	2 37/64	1 1/4	1 1/8	1 1/8	11/16
SA-404	SA-404-D	3/4	2 57/64	1 3/8	1 1/4	1 1/32	5/8
SA-501	-	3/4	3 1/32	1 5/8	1 1/2	1 1/8	25/32
SA-406	-	13/16	2 57/64	1 3/8	1 1/4	1 1/8	41/64
SA-407	-	7/8	2 57/64	1 3/8	1 3/16	1 5/16	41/64
SA-409	SA-409-D	15/16	2 57/64	1 3/8	1 5/16	1 5/16	41/64
SA-505	-	15/16	3 5/32	1 3/4	1 1/2	1 3/8	29/32
SA-410	-	1	2 61/64	1 7/16	1 1/2	1 1/2	45/64
SA-411	-	1 1/16	3 1/64	1 1/2	1 1/2	1 1/2	49/64
SA-508	-	1 1/8	3 9/32	1 7/8	1 5/8	1 5/8	1 1/32
SA-510	-	1 1/4	3 13/32	2	1 3/4	1 3/4	1 5/32

Universal wrenches must not be used with impact drivers. Maximum operating angle is 30°.

1/2" Sq. Dr. Universal Wrench Set, SAE



6 Point

APU56	6 piece, standard length: 7/16, 1/2, 9/16, 5/8, 11/16, 3/4
-------	---

BOLDED part numbers are industry popular items and are followed by common variations which may vary in price and availability.

Universal Wrenches 1/2" Sq. Dr., SAE - Extension

6 Point, Standard and Tension Type



Part Number Standard	Part Number Tension	Hex Opening In.	Shank Length (A) In.	Socket Length (B) In.	Socket Diameter (C) In.	Nose End Diameter (D) In.	Opening Depth (E) In.
KH-43-6	KN-43-6	3/8	6	13/16	5/8	17/32	7/16
-	KN-43-9	3/8	9	13/16	5/8	17/32	7/16
KH-44-6	KN-44-6	7/16	6	7/8	5/8	5/8	1/2
KH-45-3	-	1/2	3	7/8	11/16	11/16	1/2
KH-45-4	-	1/2	4	7/8	11/16	11/16	1/2
KH-45-6	KN-45-6	1/2	6	7/8	11/16	11/16	1/2
-	KN-45-9	1/2	9	7/8	11/16	11/16	1/2
KH-104-6	KN-104-6	1/2	6	1	3/4	3/4	9/16
-	KN-104-9	1/2	9	1	3/4	3/4	9/16
KH-202-6	KN-202-6	1/2	6	1	7/8	11/16	15/32
-	KN-202-8	1/2	9	1	7/8	11/16	15/32
KH-105-3	-	9/16	3	1	13/16	13/16	9/16
KH-105-6	KN-105-6	9/16	6	1	13/16	13/16	9/16
-	KN-105-9	9/16	9	1	13/16	13/16	9/16
KH-105-12	KN-105-12	9/16	12	1	13/16	13/16	9/16
KH-203-4	-	9/16	4	1 1/16	7/8	3/4	17/32
KH-203-6	KN-203-6	9/16	6	1 1/16	7/8	3/4	17/32
KH-203-9	KN-203-9	9/16	9	1 1/16	7/8	3/4	17/32
-	KN-203-12	9/16	12	1 1/16	7/8	3/4	17/32
-	KN-318-3	9/16	3	1 1/8	1	3/4	9/16
KH-318-4	KN-318-4	9/16	4	1 1/8	1	3/4	9/16
KH-205-3	-	5/8	3	1 1/8	7/8	7/8	19/32
KH-205-4	-	5/8	4	1 1/8	7/8	7/8	19/32
KH-205-6	KN-205-6	5/8	6	1 1/8	7/8	7/8	19/32
-	KN-205-9	5/8	9	1 1/8	7/8	7/8	19/32
KH-205-12	KN-205-12	5/8	12	1 1/8	7/8	7/8	19/32
KH-320-6	-	5/8	6	1 3/16	1	27/32	5/8
-	KN-320-12	5/8	12	1 3/16	1	27/32	5/8
KH-321-6	-	11/16	6	1 1/4	1	1	11/16
KH-322-6	KN-322-6	3/4	6	1 1/4	1 1/8	1 1/8	11/16
-	KN-322-9	3/4	9	1 1/4	1 1/8	1 1/8	11/16
-	KN-322-12	3/4	12	1 1/4	1 1/8	1 1/8	11/16
-	KN-404-6	3/4	6	1 3/8	1 1/4	1 1/32	41/64
KH-409-3	-	15/16	3	1 3/8	1 5/16	1 5/16	41/64
KH-409-4	-	15/16	4	1 3/8	1 5/16	1 5/16	41/64
KH-409-6	-	15/16	6	1 3/8	1 5/16	1 5/16	41/64
KH-409-12	-	15/16	12	1 3/8	1 5/16	1 5/16	41/64

Universal wrenches must not be used with impact drivers. Maximum operating angle is 30°. Actual design of universal wrenches may not be exactly like pictures above.

BOLDED part numbers are industry popular items and are followed by common variations which may vary in price and availability.

1/2" Sq. Dr. Socket Head Bits, SAE



Complete, Adapter Only, Insert Only

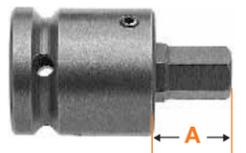

Complete	Part Number Adapter Only	Part Number Insert Only	Hex Size	Overall Length In.	Overall Length mm	Length of Insert (A) In.	Length of Insert (A) mm
SZ-22	SC-514	SZ-14-A	1/4	2 1/2	64	1 3/8	35
SZ-23	SC-514	SZ-15-A	5/16	2 1/2	64	1 3/8	35
SZ-24	SC-514	SZ-16-A	3/8	2 1/2	64	1 3/8	35
SZ-25	SC-514	SZ-17-A	1/2	2 1/2	64	1 3/8	35
SZ-42	SC-520	SZ-31-A	1/2	2 1/2	64	1 9/16	35
SZ-43	SC-514	SZ-18-A	9/16	2 1/2	64	1 3/8	35
SZ-44	SC-529	SZ-32-A	9/16	2 1/2	64	1 9/16	35
SZ-26	SC-514	SZ-19-A	5/8	2 1/2	64	1 3/8	35

For a complete listing, see page 19. Adapters with an "SC" prefix feature a set screw for locking in the bit. An "RP" prefix indicates adapters with a roll pin that is inserted through the bit.

1/2" Square Drive Sockets, Metric

6 Point & Double Hex, Standard Length

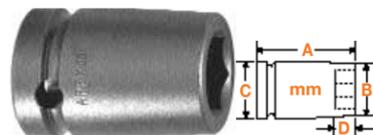

Part Number 6 Point	Part Number Double Hex	Hex Opening mm.	Overall Length (A)	Diameter Nose End (B)	Diameter Drive End (C)	Opening Depth (D)
10mm15	10mm15-D	10	38.1	16.7	23.8	6.4
11mm15	11mm15-D	11	38.1	17.5	23.8	7.2
12mm15	12mm15-D	12	38.1	19.1	23.8	7.2
13mm15	13mm15-D	13	38.1	22.2	23.8	8.7
14mm15	14mm15-D	14	38.1	22.2	23.8	11.1
15mm15	15mm15-D	15	38.1	23.8	23.8	11.1
16mm15	16mm15-D	16	38.1	25.4	25.4	11.1
17mm15	17mm15-D	17	38.1	28.6	28.6	11.1
18mm15	18mm15-D	18	38.1	28.6	28.6	11.1
19mm15	19mm15-D	19	38.1	28.6	28.6	11.9
20mm15	-	20	38.1	31.7	31.7	11.9
21mm15	21mm15-D	21	38.1	31.7	31.7	13.5
22mm15	22mm15-D	22	38.1	33.3	33.3	14.3
23mm15	23mm15-D	23	38.1	34.9	34.9	15.9
24mm15	24mm15-D	24	38.1	34.9	34.9	15.9
25mm15	-	25	38.1	38.1	38.1	15.9
26mm15	26mm15-D	26	38.1	38.1	38.1	15.9
27mm15	27mm15-D	27	41.3	41.3	41.3	17.5
28mm15	-	28	41.3	41.3	41.3	19.1
29mm15	29mm15-D	29	41.3	44.4	44.4	19.1
30mm15	30mm15-D	30	41.3	44.4	44.4	19.1
32mm15	32mm15-D	32	44.4	44.4	44.4	20.6
33mm15	-	33	44.4	47.6	47.6	20.6
34mm15	-	34	47.6	47.5	47.5	20.5
35mm15	-	35	47.6	50.8	50.8	20.6
36mm15	-	36	47.6	50.8	50.8	23.8

6 Point & Double Hex, Thin Wall, Standard Length



Part Number 6 Point	Part Number Double Hex	Hex Opening mm	Overall Length (A)	Diameter Nose End (B)	Diameter Drive End (C)	Opening Depth (D)
10mm45	10mm45-D	10	38.1	15.9	23.8	6.4
12mm45	12mm45-D	12	38.1	17.5	23.8	7.2
13mm45	13mm45-D	13	38.1	18.7	23.8	8.7
14mm45	14mm45-D	14	38.1	20.6	23.8	11.1
15mm45	15mm45-D	15	38.1	22.2	23.8	11.1
16mm45	16mm45-D	16	38.1	22.2	23.8	11.1
17mm45	17mm45-D	17	38.1	23.8	23.8	11.1
18mm45	18mm45-D	18	38.1	25.4	25.4	11.1
19mm45	-	19	38.1	26.3	26.3	11.9
21mm45	21mm45-D	21	38.1	28.6	28.6	13.5
22mm45	22mm45-D	22	38.1	30.2	31.7	14.3

6 Point & Double Hex, Long Length



Part Number 6 Point	Part Number Double Hex	Hex Opening mm	Overall Length (A)	Diameter Nose End (B)	Diameter Drive End (C)	Opening Depth (D)
10mm25	10mm25-D	10	57.1	16.7	23.8	6.4
11mm25	-	11	57.1	17.5	23.8	7.2
12mm25	12mm25-D	12	57.1	19.1	23.8	7.2
13mm25	13mm25-D	13	57.1	22.2	23.8	8.7
14mm25	-	14	57.1	22.2	23.8	11.1
15mm25	15mm25-D	15	57.1	23.8	23.8	11.1
16mm25	16mm25-D	16	57.1	25.4	25.4	11.1
17mm25	17mm25-D	17	57.1	28.6	28.6	11.1
18mm25	18mm25-D	18	57.1	28.6	28.6	11.1
19mm25	-	19	57.1	28.6	28.6	11.9
20mm25	20mm25-D	20	57.1	31.7	31.7	11.9
21mm25	21mm25-D	21	57.1	31.7	31.7	13.5
22mm25	22mm25-D	22	57.1	33.3	33.3	14.3
23mm25	23mm25-D	23	57.1	34.9	34.9	15.9
24mm25	24mm25-D	24	57.1	34.9	34.9	15.9
25mm25	-	25	57.1	38.1	38.1	15.9
26mm25	-	26	57.1	38.1	38.1	15.9
27mm25	-	27	60.3	41.3	41.3	17.5
28mm25	-	28	60.3	41.3	41.3	19.1
30mm25	30mm25-D	30	60.3	44.4	44.4	19.1
32mm25	-	32	63.5	44.4	44.4	20.6

6 Point & Double Hex, Extra Long Length



Part Number 6 Point	Part Number Double Hex	Hex Opening mm	Overall Length (A)	Diameter Nose End (B)	Diameter Drive End (C)	Opening Depth (D)
10mm35	10mm35-D	10	82.5	16.7	23.8	6.4
11mm35	-	11	82.5	17.5	23.8	7.2
12mm35	12mm35-D	12	82.5	19.1	23.8	7.2
13mm35	13mm35-D	13	82.5	22.2	23.8	8.7
14mm35	14mm35-D	14	82.5	22.2	23.8	11.1
15mm35	-	15	82.5	23.8	23.8	11.1
16mm35	16mm35-D	16	82.5	25.4	25.4	11.1
17mm35	17mm35-D	17	82.5	28.6	28.6	11.1
18mm35	18mm35-D	18	82.5	28.6	28.6	11.1
19mm35	19mm35-D	19	82.5	28.6	28.6	11.9
20mm35	20mm35-D	20	88.9	31.7	31.7	11.9
21mm35	21mm35-D	21	88.9	31.7	31.7	13.5
22mm35	22mm35-D	22	88.9	33.3	33.3	14.3
24mm35	24mm35-D	24	88.9	34.9	34.9	15.9
25mm35	-	25	88.9	38.1	38.1	15.9

BOLDED part numbers are industry popular items and are followed by common variations which may vary in price and availability.

1/2" Square Drive Sockets, Metric

6 Point & Double Hex, Thin Wall, Extra Long Length



Part Number 6 Point	Part Number Double Hex	Hex Opening mm	Overall Length (A)	Diameter Nose End (B)	Diameter Drive End (C)	Opening Depth (D)
10mm55	10mm55-D	10	82.5	15.9	23.8	6.4
11mm55	-	11	82.5	16.7	23.8	7.2
12mm55	12mm55-D	12	82.5	17.5	23.8	7.2
13mm55	13mm55-D	13	82.5	18.7	23.8	8.7
14mm55	14mm55-D	14	82.5	20.6	23.8	11.1
15mm55	15mm55-D	15	82.5	22.2	23.8	11.1
16mm55	16mm55-D	16	82.5	22.2	23.8	11.1
17mm55	17mm55-D	17	82.5	23.8	23.8	11.1
18mm55	18mm55-D	18	82.5	25.4	25.4	11.1
19mm55	-	19	82.5	26.3	26.3	11.9
21mm55	21mm55-D	21	88.9	28.6	28.6	13.5
22mm55	22mm55-D	22	88.9	30.2	31.7	14.3
24mm55	24mm55-D	24	88.9	33.3	33.3	15.9
26mm55	-	26	88.9	34.9	34.9	15.9
27mm55	27mm55-D	27	88.9	36.5	38.1	17.5
29mm55	-	29	88.9	38.1	38.1	19.1
30mm55	-	30	88.9	39.7	41.1	19.1
32mm55	-	32	88.9	42.9	42.9	20.6

Magnetic, Standard Length



Part Number Fixed Magnet	Hex Opening mm	Overall Length (A)	Diameter Nose End (B)	Diameter Drive End (C)	Opening Depth (D)
M-10mm15	10	38.1	16.7	23.8	6.4
M-11mm15	11	38.1	17.5	23.8	7.2
M-12mm15	12	38.1	19.1	23.8	7.2
M-13mm15	13	38.1	22.2	23.8	8.7
M-14mm15	14	38.1	22.2	23.8	11.1
M-15mm15	15	38.1	23.8	23.8	11.1
M-16mm15	16	38.1	25.4	25.4	11.1
M-17mm15	17	38.1	28.6	28.6	11.1
M-18mm15	18	38.1	28.5	28.5	11.1
M-19mm15	19	38.1	28.6	28.6	11.9
M-21mm15	21	38.1	31.7	31.7	13.5

BOLDED part numbers are industry popular items and are followed by common variations which may vary in price and availability.

Magnetic, Thin Wall, Standard Length



Part Number Fixed Magnet	Hex Opening mm	Overall Length (A)	Diameter Nose End (B)	Diameter Drive End (C)	Opening Depth (D)
M-13mm45	13	38.1	18.7	23.8	8.7
M-14mm45	14	38.1	20.6	23.8	11.1
M-15mm45	15	38.1	22.2	23.8	11.1

Magnetic, Long Length



Part No. Fixed Magnet	Part No. Magnetic Bolt Clearance	Hex Opening mm	Overall Length (A)	Diameter Nose End (B)	Diameter Drive End (C)	Opening Depth (D)
-	MB-10mm25	10	57.1	16.7	23.8	6.4
-	MB-12mm25	12	57.1	19.1	23.8	7.2
M-13mm25	MB-13mm25	13	57.1	22.2	23.8	8.7
-	MB-14mm25	14	57.1	22.2	23.8	11.1
M-15mm25	MB-15mm25	15	57.1	23.8	23.8	11.1
-	MB-16mm25	16	57.1	25.4	25.4	11.1
M-18mm25	MB-18mm25	18	57.1	28.6	28.5	11.1

Magnetic, Extra Long Length



Part No. Fixed Magnet	Part No. Magnetic Bolt Clearance	Hex Opening mm	Overall Length (A)	Diameter Nose End (B)	Diameter Drive End (C)	Opening Depth (D)
M-13mm35	-	13	82.5	22.2	23.8	8.7
M-13mm55*	-	13	82.5	18.7	23.8	8.7
M-15mm35	MB-15mm35	15	82.5	23.8	23.8	11.1
M-18mm35	MB-18mm35	18	82.5	28.6	28.6	11.1
M-18mm55*	-	18	82.5	25.4	25.4	11.1

*Thin Wall

1/2" Square Drive Sockets, Metric

Surface Drive, Standard Length



Part Number Surface Drive	Hex Opening mm	Overall Length (A)	Diameter Nose End (B)	Diameter Drive End (C)	Opening Depth (D)
SF-10mm15	10	38.1	16.7	23.8	6.4
SF-11mm15	11	38.1	17.5	23.8	7.2
SF-12mm15	12	38.1	19.1	23.8	7.2
SF-13mm15	13	38.1	22.2	23.8	8.7
SF-14mm15	14	38.1	22.2	23.8	11.1
SF-15mm15	15	38.1	23.8	23.8	11.1
SF-16mm15	16	38.1	25.4	25.4	11.1
SF-17mm15	17	38.1	28.6	28.6	11.1
SF-18mm15	18	38.1	28.6	28.6	11.1
SF-19mm15	19	38.1	28.6	28.6	11.9
SF-20mm15	20	38.1	31.7	31.7	11.9
SF-21mm15	21	38.1	31.7	31.7	13.5
SF-22mm15	22	38.1	33.3	33.3	14.3
SF-23mm15	23	38.1	34.9	34.9	15.9
SF-24mm15	24	38.1	34.9	34.9	15.9

Surface Drive, Thin Wall, Standard Length



Part Number Surface Drive	Hex Opening mm	Overall Length (A)	Diameter Nose End (B)	Diameter Drive End (C)	Opening Depth (D)
SF-10mm45	10	38.1	15.9	23.8	6.4
SF-11mm45	11	38.1	16.7	23.8	7.2
SF-12mm45	12	38.1	17.5	23.8	7.2
SF-13mm45	13	38.1	18.7	23.8	8.7
SF-14mm45	14	38.1	20.6	23.8	11.1
SF-15mm45	15	38.1	22.2	23.8	11.1
SF-16mm45	16	38.1	22.2	23.8	11.1
SF-17mm45	17	38.1	23.8	23.8	11.1
SF-18mm45	18	38.1	25.4	25.4	11.1
SF-19mm45	19	38.1	26.3	26.3	11.9
SF-21mm45	21	38.1	28.6	28.6	11.9

Surface Drive, Long Length

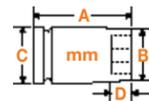

Part Number Surface Drive	Hex Opening mm	Overall Length (A)	Diameter Nose End (B)	Diameter Drive End (C)	Opening Depth (D)
SF-10mm25	10	57.1	16.7	23.8	6.4
SF-11mm25	11	57.1	17.5	23.8	7.2
SF-12mm25	12	57.1	19.1	23.8	7.2
SF-13mm25	13	57.1	22.2	23.8	7.2
SF-14mm25	14	57.1	22.2	23.8	11.1
SF-15mm25	15	57.1	23.8	23.8	11.1
SF-16mm25	16	57.1	25.4	25.4	11.1
SF-17mm25	17	57.1	28.6	28.6	11.1
SF-18mm25	18	57.1	28.6	28.6	11.1
SF-19mm25	19	57.1	28.6	28.6	11.9
SF-21mm25	21	57.1	31.7	31.7	13.5
SF-22mm25	22	57.1	33.3	33.3	14.3
SF-24mm25	24	57.1	34.9	34.9	15.9

Surface Drive, Extra Long Length



Part Number Surface Drive	Hex Opening mm	Overall Length (A)	Diameter Nose End (B)	Diameter Drive End (C)	Opening Depth (D)
SF-10mm35	10	82.5	16.7	23.8	6.4
SF-12mm35	12	82.5	17.5	23.8	7.2
SF-13mm35	13	82.5	19.1	23.8	7.2
SF-14mm35	14	82.5	22.2	23.8	11.1
SF-15mm35	15	82.5	23.8	23.8	11.1
SF-16mm35	16	82.5	25.4	25.4	11.1
SF-17mm35	17	82.5	28.6	28.6	11.1
SF-18mm35	18	82.5	28.6	28.6	11.1
SF-19mm35	19	82.5	28.6	28.6	11.9
SF-21mm35	21	88.9	31.7	31.7	13.5
SF-22mm35	22	88.9	33.3	33.3	14.3
SF-24mm35	24	88.9	34.9	34.9	15.9

Surface Drive, Thin Wall, Extra Long Length



Part Number Surface Drive	Hex Opening mm	Overall Length (A)	Diameter Nose End (B)	Diameter Drive End (C)	Opening Depth (D)
SF-10mm55	10	82.5	15.9	23.8	6.4
SF-11mm55	11	82.5	16.7	23.8	7.2
SF-13mm55	13	82.5	18.7	23.8	8.7
SF-14mm55	14	82.5	20.6	23.8	11.1
SF-15mm55	15	82.5	22.2	23.8	11.1
SF-16mm55	16	82.5	22.2	23.8	11.1
SF-17mm55	17	82.5	23.8	23.8	11.1
SF-18mm55	18	82.5	25.4	25.4	11.1
SF-19mm55	19	82.5	26.3	26.3	11.9
SF-21mm55	21	88.9	28.6	28.6	13.5
SF-22mm55	22	88.9	30.2	31.7	15.9

1/2" Sq. Dr. Sockets For Metric Sheet Metal Screws

6 Point & 6 Point Magnetic, For Regular Screws



Part Number 6 Point	Part Number Magnetic	Hex Opening mm.	Overall Length (A)	Diameter Nose End (B)	Diameter Drive End (C)	Opening Depth (D)
-	M-13mmE5	13	38.1	22.2	23.8	8.7
15mmE5	M-15mmE5	15	38.1	23.8	23.8	11.1

BOLDED part numbers are industry popular items and are followed by common variations which may vary in price and availability.

1/2" Sq. Dr. Socket Sets, Metric

6 Point



APS511M 11 piece, standard length:
10mm, 11mm, 12mm, 13mm, 14mm, 15mm, 16mm, 17mm, 18mm, 19mm, 21mm

1/2" Sq. Dr. Universal Wrenches, Metric



6 Point

Part Number 6 Point	Hex Opening mm	Overall Length (A) mm	Socket Length (B) mm	Socket Diameter (C) mm	Nose End Diameter (D) mm	Clearance Depth (E) mm
SA-57-13m	13	58	25.4	22.2	17.5	11.9
SA-57-14m	14	60	27.0	22.2	19.1	13.5
SA-58-15m	15	62	28.6	25.4	19.8	14.3
SA-58-16m	16	64	30.2	25.4	21.4	15.9
SA-58-17m	17	66	31.8	25.4	25.4	17.5
SA-58-18m	18	66	31.8	25.4	25.4	17.5
SA-510-19m	19	73	34.9	31.8	26.2	16.3
SA-510-20m	20	73	34.9	31.8	27.0	16.3
SA-510-21m	21	73	34.9	31.8	28.6	16.3
SA-510-22m	22	73	34.9	31.8	31.8	16.3
SA-510-24m	24	73	34.9	31.8	34.9	16.3

1/2" Sq. Dr. Universal Wrench Set, Metric



6 Point

APU56M 6 piece, standard length:
13mm, 14mm, 15mm, 16mm, 17mm, 18mm

BOLDED part numbers are industry popular items and are followed by common variations which may vary in price and availability.

1/2" Sq. Dr. Universal Wrenches, Metric - Extension

6 Point, Standard and Tension Type



Part Number Standard	Part Number Tension	Hex Opening mm	Shank Length (A) mm	Socket Length (B) mm	Socket Diameter (C) mm	Nose End Diameter (D) mm	Clearance Depth (E) mm
-	KN-7-12m-6	12	152	23.8	22.2	17.5	10.3
-	KN-7-12m-9	12	229	23.8	22.2	17.5	10.3
KH-7-13m-3	-	13	76	25.4	22.2	17.5	11.9
KH-7-13m-4	-	13	102	25.4	22.2	17.5	11.9
KH-7-13m-6	KN-7-13m-6	13	152	25.4	22.2	17.5	11.9
KH-7-13m-9	KN-7-13m-9	13	229	25.4	22.2	17.5	11.9
-	KN-7-13m-12	13	305	25.4	22.2	17.5	11.9
KH-7-14m-6	KN-7-14m-6	14	152	27.0	22.2	19.1	13.5
-	KN-7-14m-9	14	229	27.0	22.2	19.1	13.5
KH-8-15m-3	-	15	76	28.6	25.4	19.8	14.3
KH-8-15m-6	KN-8-15m-6	15	152	28.6	25.4	19.8	14.3
KH-8-15m-9	KN-8-15m-9	15	229	28.6	25.4	19.8	14.3
-	KN-8-15m-12	15	305	28.6	25.4	19.8	14.3
KH-8-16m-3	-	16	76	30.2	25.4	21.4	15.9
KH-8-16m-4	-	16	102	30.2	25.4	21.4	15.9
KH-8-16m-9	KN-8-16m-9	16	229	30.2	25.4	21.4	15.9
KH-8-16m-12	KN-8-16m-12	16	305	30.2	25.4	21.4	15.9
KH-8-17m-3	-	17	76	31.8	25.4	25.4	17.5
KH-8-17m-4	-	17	102	31.8	25.4	25.4	17.5
KH-8-17m-6	KN-8-17m-6	17	152	31.8	25.4	25.4	17.5
KH-8-17m-9	KN-8-17m-9	17	229	31.8	25.4	25.4	17.5
KH-8-18m-3	-	18	76	31.8	25.4	25.4	17.5
KH-8-18m-4	-	18	102	31.8	25.4	25.4	17.5
KH-8-18m-6	KN-8-18m-6	18	152	31.8	25.4	25.4	17.5
KH-8-18m-9	KN-8-18m-9	18	229	31.8	25.4	25.4	17.5
-	KN-8-18m-12	18	305	31.8	25.4	25.4	17.5
KH-10-19m-3	-	19	76	34.9	31.8	26.2	16.3
KH-10-19m-6	-	19	152	34.9	31.8	26.2	16.3
KH-10-19m-9	-	19	229	34.9	31.8	26.2	16.3
KH-10-19m-12	-	19	305	34.9	31.8	26.2	16.3

Universal wrenches must not be used with impact drivers. Maximum operating angle is 30°.

1/2" Sq. Dr. Socket Head Bits, Metric

Complete, Adapter Only, Insert Only



Complete	Part Number Adapter Only	Part Number Insert Only	Hex Size	Overall Length In.	Length of Insert (A) mm		
SZ-5-7-8mm	SC-514	SZ-7-8mm	8mm	2 1/2	64	1 3/8	35
SZ-5-7-10mm	SC-514	SZ-7-10mm	10mm	2 1/2	64	1 3/8	35
SZ-5-7-12mm	SC-514	SZ-7-12mm	12mm	2 1/2	64	1 3/8	35
SZ-5-7-14mm	SC-514	SZ-7-14mm	14mm	2 1/2	64	1 3/8	35
SZ-5-10-14mm	RP-520	SZ-10-14mm	14mm	2 1/2	64	1 9/16	40
SZ-5-10-17mm	RP-520	SZ-10-17mm	17mm	2 1/2	64	1 9/16	40

For a complete listing, see page 20.

1/2" Sq. Dr. Sockets For Spline Fasteners

Standard & Long Length

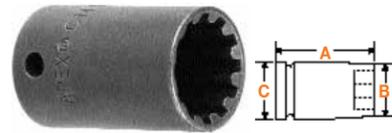

Part Number	Spline Size	Nominal Size	Overall Length (A)		Diameter Nose End (B)		Diameter Drive End (C)	
			In.	mm	In.	mm	In.	mm
CMS-5416	16	1/2	1 1/4	32	23/32	18	7/8	22
CMS-5422	22	11/16	1 1/2	38	31/32	25	31/32	25
CMS-5426	26	13/16	1 1/2	38	1 1/8	29	1 1/8	29
CMS-5430	30	15/16	1 1/2	38	1 1/4	32	1 1/4	32

Apex spline sockets conform to military specifications MS-37787 and MIL-W-8982C.

1/2" Sq. Dr. Torx® Sockets

For External Torx Screws



Part Number	Driver Size	Overall Length (A)		Diameter Nose End (B)		Diameter Drive End (C)	
		In.	mm	In.	mm	In.	mm
TX-5110	E-10	1 1/2	38	9/16	13	1	25
TX-5112	E-12	1 1/2	38	5/8	16	1	25
TX-5114	E-14	1 1/2	38	11/16	18	1	25
TX-5116	E-16	1 1/2	38	13/16	21	1	25
TX-5118	E-18	1 1/2	38	7/8	22	1	25
TX-5120	E-20	1 1/2	38	1	25	1 3/16	30
TX-5124	E-24	1 1/2	38	1 5/16	33	1 5/16	33

For External Torx Screws, Thin Wall



Part Number	Driver Size	Overall Length (A)		Diameter Nose End (B)		Diameter Drive End (C)	
		In.	mm	In.	mm	In.	mm
TX-5408	E-8	1 1/2	38	3/8	10	7/8	22
TX-5410	E-10	1 1/2	38	1/2	13	7/8	22
TX-5412	E-12	1 1/2	38	9/16	14	7/8	22
TX-5414	E-14	1 1/2	38	5/8	16	7/8	22
TX-5416	E-16	1 1/2	38	7/8	22	7/8	22
TX-5418	E-18	1 1/2	38	15/16	24	15/16	24
TX-5420	E-20	1 1/2	38	1 1/16	27	1 1/16	27

BOLDED part numbers are industry popular items and are followed by common variations which may vary in price and availability.

1/2" Sq. Dr. Extensions

1 23/32" to 18"
(44mm to 457mm)
Length



Part Number	Male Square In.	Type of Lock	Overall Length In.	Overall Length mm
EX-504	1/2	Pin	1 23/32	44
EX-504-B	1/2	Ball	1 23/32	44
EX-508-2	1/2	Pin	2	51
EX-508-B-2	1/2	Ball	2	51
EX-508-3	1/2	Pin	3	76
EX-508-B-3	1/2	Ball	3	76
EX-508-4	1/2	Pin	4	102
EX-508-B-4	1/2	Ball	4	102
EX-508-5	1/2	Pin	5	127
EX-508-B-5	1/2	Ball	5	127
EX-508-6	1/2	Pin	6	152
EX-508-B-6	1/2	Ball	6	152
EX-508-8	1/2	Pin	8	203
EX-508-B-8	1/2	Ball	8	203
EX-508-9	1/2	Pin	9	229
EX-508-B-9	1/2	Ball	9	229
EX-508-10	1/2	Pin	10	254
EX-508-B-10	1/2	Ball	10	254
EX-508-12	1/2	Pin	12	305
EX-508-B-12	1/2	Ball	12	305
EX-508-15	1/2	Pin	15	381
EX-508-B-15	1/2	Ball	15	381
EX-508-16	1/2	Pin	16	406
EX-508-18	1/2	Pin	18	457

1/2" Sq. Dr. Adapters

1/4" to 5/8" Male Square



Part Number	Male Square In.	Female Square In.	Type of Lock	Overall Length In.	Overall Length mm
EX-260	1/4	1/2	Pin	1 1/2	38
EX-260-B	1/4	1/2	Ball	1 1/2	38
EX-258-B-2	1/4	1/2	Ball	2	51
EX-258-4	1/4	1/2	Pin	4	102
EX-375	3/8	1/2	Pin	1 1/2	38
EX-375-B	3/8	1/2	Ball	1 1/2	38
EX-377-2	3/8	1/2	Pin	2	51
EX-377-B-2	3/8	1/2	Ball	2	51
EX-377-3	3/8	1/2	Pin	3	76
EX-377-B-3	3/8	1/2	Ball	3	76
EX-377-4	3/8	1/2	Pin	4	102
EX-377-B-4	3/8	1/2	Ball	4	102
EX-377-5	3/8	1/2	Pin	5	127
EX-377-B-5	3/8	1/2	Ball	5	127
EX-377-6	3/8	1/2	Pin	6	152
EX-377-B-6	3/8	1/2	Ball	6	152
EX-377-8	3/8	1/2	Pin	8	203
EX-377-B-9	3/8	1/2	Ball	9	229
EX-377-10	3/8	1/2	Pin	10	254
EX-377-B-10	3/8	1/2	Ball	10	254
EX-377-12	3/8	1/2	Pin	12	305
EX-377-B-12	3/8	1/2	Ball	12	305
EX-377-15	3/8	1/2	Pin	15	381

BOLDED part numbers are industry popular items and are followed by common variations which may vary in price and availability.

1/2" Sq. Dr. Adapters

5/8" to 3/4" Male Square



Part Number	Male Square In.	Female Square In.	Type of Lock	Overall Length In.	Overall Length mm
EX-623	5/8	1/2	Pin	1 1/2	38
EX-623-B	5/8	1/2	Ball	1 1/2	38
EX-626-3	5/8	1/2	Pin	3	76
EX-751	3/4	1/2	7/32 drill hole	1 13/16	46
EX-751-B	3/4	1/2	Ball	1 13/16	46

BOLDED part numbers are industry popular items and are followed by common variations which may vary in price and availability.

1/2" Sq. Dr. Universal Adapters



3/8" to 3/4" Male Square



Part Number	Male Sq. In.	Female Sq. In.	Type of Lock	Overall Length In.	Overall Length mm	Largest Diameter in.	Largest Diameter mm
MF-39	3/8	1/2	Pin	2 9/16	65	7/8	22
MF-39B	3/8	1/2	Ball	2 9/16	65	7/8	22
MF-50	1/2	1/2	Pin	2 11/16	68	1	25
MF-50B	1/2	1/2	Ball	2 11/16	68	1	25
MF-55	1/2	1/2	Pin	3 1/16	78	1 1/4	32
MF-55B	1/2	1/2	Ball	3 1/16	78	1 1/4	32
MF-70	3/4	1/2	7/32 drill hole	3 5/8	92	1 1/2	38
MF-70B	3/4	1/2	Ball	3 5/8	92	1 1/2	38

Universal wrenches must not be used with impact drivers. Maximum operating angle is 30°.

1/2" Sq. Dr. Universal Adapters - Extension



(Standard Type Shown)

1/2" Male Square

Part Number	Male Square In.	Female Square In.	Type of Lock	Largest Dia. In.	Largest Dia. mm	
KHM-37-6	KNM-37-6	3/8	1/2	Pin	3/4	19
KHM-38-6	KNM-38-6	3/8	1/2	Pin	7/8	22
KHM-50-6	KNM-50-6	1/2	1/2	Pin	1	25
KHM-50-B-6	KNM-50-B-6	1/2	1/2	Ball	1	25

Universal wrenches must not be used with impact drivers. Maximum operating angle is 30°. Standard lengths are 3", 6", 9" and 12" (76, 152, 229 and 305mm)

If the tool you need does not appear in this catalog, give us a call. The odds are, we may have what you need as a non-catalog item. If not, our experienced staff of tooling experts can design and manufacture "specials" to meet the needs of your specific application. Give us a call at 1-800-845-5629 or visit our website www.apex-tools.com.

5/8" Square Drive Sockets, SAE

6 Point & Double Hex, Standard Length

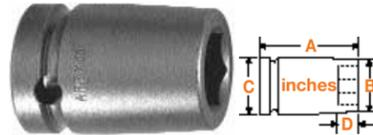

Part Number 6 Point	Part Number Double Hex	Hex Opening In.	Overall Length (A)	Diameter Nose End (B)	Diameter Drive End (C)	Opening Depth (D)
6118	-	9/16	1 7/8	7/8	1 1/4	7/16
6120	6120-D	5/8	1 7/8	1	1 1/4	7/16
6122	-	11/16	1 7/8	1 1/8	1 1/4	7/16
6124	-	3/4	1 7/8	1 1/4	1 1/4	15/32
6128	-	7/8	1 7/8	1 3/8	1 3/8	9/16
6134	-	1 1/16	2	1 5/8	1 5/8	11/16
6136	-	1 1/8	2	1 5/8	1 5/8	3/4
6140	-	1 1/4	2	1 7/8	1 7/8	13/16
6142	-	1 5/16	2	2	2	13/16
6144	-	1 3/8	2 1/8	2	2	13/16
6146	-	1 7/16	2 1/8	2 1/8	2 1/8	15/16
6148	-	1 1/2	2 1/4	2 1/8	2 1/8	1

6 Point & Double Hex, Thin Wall Standard Length



Part Number 6 Point	Hex Opening In.	Overall Length (A)	Diameter Nose End (B)	Diameter Drive End (C)	Opening Depth (D)
6426	13/16	1 7/8	1 1/8	1 1/4	17/32
6430	15/16	2	1 5/16	1 5/16	5/8

6 Point & Double Hex, Extra Long Length



Part Number 6 Point	Hex Opening In.	Overall Length (A)	Diameter Nose End (B)	Diameter Drive End (C)	Opening Depth (D)
6320	5/8	3 1/2	1	1 1/4	7/16
6322	11/16	3 1/2	1 1/8	1 1/4	7/16
6324	3/4	3 1/2	1 1/4	1 1/4	15/32
6326	13/16	3 1/2	1 1/4	1 1/4	17/32
6330	15/16	3 1/2	1 1/2	1 1/2	5/8
6336	1 1/8	3 1/2	1 5/8	1 5/8	3/4
6340	1 1/4	3 1/2	1 7/8	1 7/8	13/16
6342	1 5/16	3 1/2	2	2	13/16
6344	1 3/8	3 1/2	2	2	13/16
6348	1 1/2	3 1/2	2 1/8	2 1/8	1

6 Point & Double Hex, Thin Wall, Extra Long Length



Part Number 6 Point	Part Number Double Hex	Hex Opening In.	Overall Length (A)	Diameter Nose End (B)	Diameter Drive End (C)	Opening Depth (D)
-	6520-D	5/8	3 1/2	15/16	1 1/4	7/16
6524	6524-D	3/4	3 1/2	1 1/16	1 1/4	15/32
-	6528-D	7/8	3 1/2	1 3/16	1 1/4	9/16

Surface Drive & Fast Lead, Standard Length



Part Number 6 Point	Part Number Fast Lead	Hex Opening In.	Overall Length (A)	Diameter Nose End (B)	Diameter Drive End (C)	Opening Depth (D)
SF-6118	-	9/16	1 7/8	7/8	1 1/4	7/16
SF-6120	-	5/8	1 7/8	1	1 1/4	7/16
SF-6124	FL-6124	3/4	1 7/8	1 1/4	1 1/4	15/32
SF-6424*	-	3/4	1 7/8	1 1/16	1 1/4	15/32
SF-6128	FL-6128	7/8	1 7/8	1 3/8	1 3/8	9/16

*Thin Wall

Surface Drive & Fast Lead, Thin Wall, Extra Long Length



Part Number 6 Point	Part Number Fast Lead	Hex Opening In.	Overall Length (A)	Diameter Nose End (B)	Diameter Drive End (C)	Opening Depth (D)
SF-6320	-	5/8	3 1/2	1	1 1/4	7/16
SF-6324	FL-6324	3/4	3 1/2	1 1/4	1 1/4	15/32
SF-6524*	-	3/4	3 1/2	1 1/16	1 1/4	15/32
SF-6326	-	13/16	3 1/2	1 1/4	1 1/4	17/32
SF-6328	-	7/8	3 1/2	1 3/8	1 3/8	9/16
SF-6330	-	15/16	3 1/2	1 1/2	1 1/2	5/8

*Thin Wall

5/8" Sq. Dr. Sockets, Metric

6 Point & Surface Drive, Standard Length



Part Number 6 Point	Part No. Surface Drive	Hex Opening mm	Overall Length (A)	Diameter Nose End (B)	Diameter Drive End (C)	Opening Depth (D)
-	SF-15mm16	15	48	23.8	31.8	11.1
16mm16	SF-16mm16	16	48	25.4	31.8	11.1
17mm16	SF-17mm16	17	48	28.6	31.8	11.1
18mm16	SF-18mm16	18	48	28.5	31.8	11.1
-	SF-19mm16	19	48	31.8	31.8	11.9
21mm16	SF-21mm16	21	48	31.8	31.8	13.5
-	SF-22mm16	22	48	34.9	34.9	14.3
24mm16	SF-24mm16	24	51	38.1	38.1	15.9

6 Point & Surface Drive, Extra Long Length



Part Number 6 Point	Part No. Surface Drive	Hex Opening mm	Overall Length (A)	Diameter Nose End (B)	Diameter Drive End (C)	Opening Depth (D)
-	SF-15mm36	15	89	23.8	31.8	11.1
17mm36	-	17	89	25.4	31.8	11.1
-	SF-18mm36	18	89	28.6	31.8	11.1
19mm36	SF-19mm36	19	89	31.8	31.8	11.9
21mm36	SF-21mm36	21	89	31.8	31.8	13.5
-	SF-22mm36	22	89	34.9	34.9	14.3
24mm36	SF-24mm36	24	89	38.1	38.1	15.9

5/8" Sq. Dr. Extensions

1 7/8" to 15" (48mm to 381mm) Length



Part Number	Male Square In.	Type of Lock	Overall Length In.	Overall Length mm
EX-624	5/8	Pin	1 7/8	48
EX-624-B	5/8	Ball	1 7/8	48
EX-627-3	5/8	Pin	3	76
EX-627-4	5/8	Pin	4	102
EX-627-6	5/8	Pin	6	152
EX-627-8	5/8	Pin	8	203
EX-627-10	5/8	Pin	10	254
EX-627-12	5/8	Pin	12	305

5/8" Sq. Dr. Adapters



1/2" to 3/4" Male Square

Part Number	Male Square In.	Female Square In.	Type of Lock	Overall Length In.	Overall Length mm
EX-505	1/2	5/8	Pin	1 7/8	48
EX-505-B	1/2	5/8	Ball	1 7/8	48
EX-509-3	1/2	5/8	Pin	3	76
EX-509-4	1/2	5/8	Pin	4	102
EX-509-5	1/2	5/8	Pin	5	127
EX-509-6	1/2	5/8	Pin	6	152
EX-509-10	1/2	5/8	Pin	10	254
EX-509-12	1/2	5/8	Pin	12	305
EX-752	3/4	5/8	7/32 Drill Hole	1 7/8	48
EX-752-B	3/4	5/8	Ball	1 7/8	48

5/8" Sq. Dr. Universal Adapters



1/2" to 5/8" Male Square

Part Number	Male Square In.	Female Square In.	Type of Lock	Overall Length In.	Overall Length mm	Largest Diameter In.	Largest Diameter mm
MF-51	1/2	5/8	Pin	3 5/16	84	1 1/4	32
MF-62	5/8	5/8	Pin	3 1/4	83	1 1/4	32
MF-62B	5/8	5/8	Ball	3 1/4	83	1 1/4	32

Universal wrenches must not be used with impact drivers. Maximum operating angle is 30°.

BOLDED part numbers are industry popular items and are followed by common variations which may vary in price and availability.

BOLDED part numbers are industry popular items and are followed by common variations which may vary in price and availability.

3/4" Square Drive Sockets, SAE

6 Point & Double Hex, Standard Length



Part Number 6 Point	Part Number Double Hex	Hex Opening In.	Overall Length (A)	Diameter Nose End (B)	Diameter Drive End (C)	Opening Depth (D)
7120	7120-D	5/8	2	1 1/16	1 1/2	7/16
7122	7122-D	11/16	2	1 1/8	1 1/2	7/16
7124	7124-D	3/4	2	1 1/4	1 1/2	15/32
7128	7128-D	7/8	2	1 1/2	1 1/2	9/16
7130	7130-D	15/16	2	1 1/2	1 1/2	5/8
7132	7132-D	1	2	1 5/8	1 5/8	5/8
7134	7134-D	1 1/16	2	1 3/4	1 3/4	11/16
7136	7136-D	1 1/8	2 1/8	1 3/4	1 3/4	3/4
7140	7140-D	1 1/4	2 1/8	2	1 3/4	13/16
7142	7142-D	1 5/16	2 1/8	2	1 3/4	13/16
7144	-	1 3/8	2 1/8	2 1/8	2 1/8	13/16
7146	-	1 7/16	2 1/4	2 1/4	2 1/8	15/16
7148	7148-D	1 1/2	2 1/4	2 1/4	2 1/8	1
7152	7152-D	1 5/8	2 1/4	2 1/2	2 1/8	1 1/8
7154	7154-D	1 11/16	2 1/4	2 1/2	2 1/8	1 1/8
7156	-	1 3/4	2 1/4	2 5/8	2 1/8	1 1/8
7158	-	1 13/16	2 1/4	2 3/4	2 1/8	1 1/4
7160	7160-D	1 7/8	2 1/4	2 3/4	2 1/8	1 1/4
7164	7164-D	2	2 3/8	2 7/8	2 1/8	1 3/8
7168	-	2 1/8	2 3/8	3 1/8	2 1/8	1 3/8
7170	7170-D	2 3/16	2 1/2	3 1/8	2 1/8	1 1/2
7172	7172-D	2 1/4	2 1/2	3 1/4	2 1/8	1 1/2
7176	-	2 3/8	2 5/8	3 1/2	2 1/8	1 5/8
7180	7180-D	2 1/2	2 5/8	3 1/2	2 1/8	1 5/8

6 Point & Double Hex, Thin Wall Standard Length



Part Number 6 Point	Part Number Double Hex	Hex Opening In.	Overall Length (A)	Diameter Nose End (B)	Diameter Drive End (C)	Opening Depth (D)
7424	7424-D	3/4	2	1 1/8	1 3/8	15/32
7426	-	13/16	2	1 1/4	1 3/8	17/32
7428	7428-D	7/8	2	1 5/16	1 3/8	9/16
7430	7430-D	15/16	2	1 3/8	1 3/8	5/8
7432	-	1	2	1 7/16	1 7/16	5/8
7434	-	1 1/16	2	1 1/2	1 1/2	11/16
7436	-	1 1/8	2 1/8	1 5/8	1 5/8	3/4
7438	-	1 3/16	2 1/8	1 5/8	1 5/8	3/4
7442	7442-D	1 5/16	2 1/8	1 7/8	1 3/4	13/16
7446	-	1 7/16	2 1/4	2	1 3/4	15/16
7448	-	1 1/2	2 1/4	2 1/8	2 1/8	1
7454	-	1 11/16	2 1/4	2 3/8	2 1/8	1 1/8
7456	-	1 3/4	2 1/4	2 7/16	2 1/8	1 1/8

BOLDED part numbers are industry popular items and are followed by common variations which may vary in price and availability.

6 Point & Double Hex, Extra Long Length



Part Number 6 Point	Part Number Double Hex	Hex Opening In.	Overall Length (A)	Diameter Nose End (B)	Diameter Drive End (C)	Opening Depth (D)
7324SKT	7324-D	3/4	4	1 1/4	1 1/2	15/32
7328	-	7/8	4	1 7/16	1 1/2	9/16
7330	7330-D	15/16	4	1 1/2	1 1/2	5/8
7332	7332-D	1	4	1 1/2	1 1/2	5/8
7334	-	1 1/16	4	1 5/8	1 5/8	11/16
7336	7336-D	1 1/8	4	1 3/4	1 3/4	3/4
7340	-	1 1/4	4	1 7/8	1 3/4	13/16
7342	-	1 5/16	4	2	1 3/4	13/16
7346	-	1 7/16	4	2 1/8	2 1/8	15/16
7348	-	1 1/2	4	2 1/4	2 1/8	1
7352	-	1 5/8	4	2 1/2	2 1/8	1 1/8
7356	-	1 3/4	4	2 5/8	2 1/8	1 1/8
7358	-	1 13/16	4	2 3/4	2 1/8	1 1/4
7360	-	1 7/8	4	2 3/4	2 1/8	1 1/4
7362	-	1 15/16	4	2 3/4	2 1/8	1 1/4
7364	-	2	4 1/8	2 7/8	2 1/8	1 3/8
7372	-	2 1/4	4 1/4	3 1/4	2 1/8	1 1/2

6 Point & Double Hex, Thin Wall, Extra Long Length

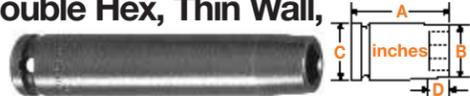

Part Number 6 Point	Part Number Double Hex	Hex Opening In.	Overall Length (A)	Diameter Nose End (B)	Diameter Drive End (C)	Opening Depth (D)
7524	-	3/4	4	1 1/8	1 3/8	15/32
7528	-	7/8	4	1 3/8	1 3/8	9/16
7530	7530-D	15/16	4	1 3/8	1 3/8	5/8
7536	7536-D	1 1/8	4	1 5/8	1 5/8	3/4
7540	-	1 1/4	4	1 3/4	1 3/4	13/16
7542	-	1 5/16	4	1 7/8	1 3/4	13/16
7548	-	1 1/2	4	2 1/8	2 1/8	1
7552	-	1 5/8	4	2 1/4	2 1/8	1 1/8
7556	-	1 3/4	4	2 1/2	2 1/8	1 1/8

3/4" Square Drive Sockets For SAE Square Nuts

Single Square & Double Square, Standard Length



Part No. Single Square	Square Opening In.	Overall Length (A)	Diameter Nose End (B)	Diameter Drive End (C)	Opening Depth (D)
7624	3/4	2	1 1/2	1 1/2	15/32
7628	7/8	2	1 3/4	1 3/4	5/8
7630	15/16	2 1/8	1 7/8	1 3/4	5/8
7632	1	2 1/8	2	1 3/4	5/8
7636	1 1/8	2 1/8	2 1/8	2 1/8	3/4

3/4" Square Drive Universal Wrenches, SAE



6 Point

Part Number 6 Point	Hex Opening In.	Overall Length (A) In.	Socket Length (B) In.	Socket Diameter (C) In.	Nose End Diameter (D) In.	Clearance Depth (E) In.
SA-535	15/16	3 25/32	1 3/4	1 1/2	1 3/8	29/32
SA-601	15/16	4 1/32	1 15/16	1 3/4	1 1/2	29/32
SA-537	1 1/16	3 29/32	1 7/8	1 5/8	1 5/8	1 1/32
SA-603	1 1/16	4 3/32	2	1 3/4	1 5/8	31/32
SA-538	1 1/8	3 29/32	1 7/8	1 5/8	1 5/8	1 1/32
SA-604	1 1/8	4 5/32	2 1/16	1 3/4	1 3/4	1 1/32
SA-606	1 1/4	4 7/32	2 1/8	1 7/8	1 7/8	1 3/32
SA-607	1 5/16	4 7/32	2 1/8	1 7/8	1 7/8	1 3/32
SA-609	1 7/16	4 11/32	2 1/4	2 1/8	2 1/8	1 5/32
SA-610	1 1/2	4 11/32	2 1/4	2 1/4	2 1/4	1 5/32
SA-712	1 5/8	4 11/32	2 3/8	2 3/8	2 3/8	1 3/16
SA-716	1 7/8	4 11/32	2 3/8	2 5/8	2 5/8	1 3/16

Universal wrenches must not be used with impact drivers. Maximum operating angle is 30°.

BOLDED part numbers are industry popular items and are followed by common variations which may vary in price and availability.

3/4" Sq. Dr. Sockets, Metric

6 Point, Standard Length



Part Number 6 Point	Hex Opening mm	Overall Length (A)	Diameter Nose End (B)	Diameter Drive End (C)	Opening Depth (D)
17mm17	17	51	31.8	38.1	11.2
18mm17	18	51	31.8	38.1	11.2
19mm17	19	51	31.8	38.1	11.9
20mm17	20	51	33.3	38.1	11.9
21mm17	21	51	34.9	38.1	13.5
22mm17	22	51	38.1	38.1	14.3
22mm47*	22	51	33.3	34.9	14.3
24mm17	24	51	38.1	38.1	15.9
24mm47*	24	51	34.9	34.9	15.9
26mm17	26	51	41.3	41.3	15.9
27mm17	27	51	44.4	44.4	17.5
27mm47*	27	51	38.1	38.1	17.5
29mm17	29	54	47.6	44.4	19.1
30mm17	30	54	47.6	44.4	19.1
30mm47*	30	54	41.3	41.3	19.1
32mm17	32	54	50.8	44.4	20.6
32mm47*	32	54	44.4	44.4	20.6
33mm17	33	54	50.8	44.4	20.6
36mm17	36	57	57.1	54.0	23.8
37mm17	37	57	57.1	54.0	23.8
41mm17	41	57	63.5	54.0	31.8
46mm17	46	57	69.9	54.0	31.8

*Thin Wall

6 Point, Extra Long Length



Part Number 6 Point	Hex Opening mm	Overall Length (A)	Diameter Nose End (B)	Diameter Drive End (C)	Opening Depth (D)
21mm37	21	102	34.9	38.1	13.5
21mm57*	21	102	34.9	34.9	13.5
22mm57*	22	102	34.9	34.9	14.3
24mm37	24	102	38.1	38.1	15.9
24mm57*	24	102	34.9	34.9	15.9
25mm37	25	102	38.1	38.1	15.9
27mm37	27	102	41.3	41.3	17.5
27mm57*	27	101.6	38.1	38.1	17.5
28mm37	28	101.6	44.4	44.4	19.1
29mm37	29	101.6	44.4	44.4	19.1
30mm37	30	101.6	44.4	44.4	19.1
30mm57*	30	101.6	42.9	42.9	19.1
32mm37	32	101.6	47.6	44.4	20.6
33mm37	33	101.6	50.8	44.4	20.6
34mm37	34	101.6	54.0	54.0	20.6
36mm37	36	101.6	54.0	54.0	23.8
41mm37	41	101.6	63.5	54.0	28.6

*Thin Wall

BOLDED part numbers are industry popular items and are followed by common variations which may vary in price and availability.

3/4" Sq. Dr. Extensions

2 1/4" to 15" (57mm to 381mm) Length



Part Number	Male Square In.	Type of Lock	Overall Length In.	Overall Length mm
EX-753	3/4	7/32 Drill Hole	2 1/4	57
EX-753-B	3/4	Ball	2 1/4	57
EX-755-4	3/4	7/32 Drill Hole	4	102
EX-755-B-4	3/4	Ball	4	102
EX-755-6	3/4	7/32 Drill Hole	6	152
EX-755-B-6	3/4	Ball	6	152
EX-755-8	3/4	7/32 Drill Hole	8	203
EX-755-B-8	3/4	Ball	8	203
EX-755-10	3/4	7/32 Drill Hole	10	254
EX-755-12	3/4	7/32 Drill Hole	12	305
EX-755-B-12	3/4	Ball	12	305
EX-755-15	3/4	7/32 Drill Hole	15	381
EX-755-B-15	3/4	Ball	15	381

3/4" Sq. Dr. Adapters

1/2" to 1" Male Square



Part Number	Male Square In.	Female Square In.	Type of Lock	Overall Length In.	Overall Length mm
EX-506	1/2	3/4	Pin	2	51
EX-506-B	1/2	3/4	Ball	2	51
EX-510-3	1/2	3/4	Pin	3	76
EX-510-B-3	1/2	3/4	Ball	3	76
EX-510-4	1/2	3/4	Pin	4	102
EX-510-B-4	1/2	3/4	Ball	4	102
EX-510-B-5	1/2	3/4	Ball	5	127
EX-510-6	1/2	3/4	Pin	6	152
EX-510-B-6	1/2	3/4	Ball	6	152
EX-510-8	1/2	3/4	Pin	8	203
EX-510-B-8	1/2	3/4	Ball	8	203
EX-625	5/8	3/4	Pin	2	51
EX-625-B	5/8	3/4	Ball	2	51
EX-628-3	5/8	3/4	Pin	3	76
EX-1000	1	3/4	9/32 Drill Hole	2 9/16	65
EX-1000-B	1	3/4	Ball	2 9/16	65

3/4" Sq. Dr. Universal Adapters



3/4" Male Square

Part Number	Male Sq. In.	Female Sq. In.	Type of Lock	Overall Length In.	Overall Length mm	Largest Diameter In.	Largest Diameter mm
MF-75	3/4	3/4	7/32 Drill Hole	4	102	1 1/2	38
MF-75B	3/4	3/4	Ball	4	102	1 1/2	38
MF-76	3/4	3/4	7/32 Drill Hole	4 3/8	111	1 3/4	45
MF-76B	3/4	3/4	Ball	4 3/8	111	1 3/4	45

Universal wrenches must not be used with impact drivers. Maximum operating angle is 30°.

1" Square Drive Sockets, SAE

6 Point & Double Hex, Standard Length



Part Number 6 Point	Part Number Double Hex	Hex Opening In.	Overall Length (A)	Diameter Nose End (B)	Diameter Drive End (C)	Opening Depth (D)
-	8124-D	3/4	2 1/8	1 5/16	2	13/16
8126	-	13/16	2 1/8	1 3/8	2	13/16
-	8128-D	7/8	2 1/8	1 1/2	2	13/16
-	8130-D	15/16	2 1/8	1 1/2	2	13/16
-	8132-D	1	2 1/8	1 5/8	2	13/16
-	8134-D	1 1/16	2 1/8	1 11/16	2	13/16
-	8136-D	1 1/8	2 1/8	1 3/4	2	13/16
8138	8138-D	1 3/16	2 1/8	2 1/8	2	13/16
-	8140-D	1 1/4	2 1/8	2 1/8	2 1/8	13/16
8142	8142-D	1 5/16	2 1/8	2 1/8	2 1/8	13/16
-	8144-D	1 3/8	2 1/8	2 1/8	2 1/8	13/16
-	8146-D	1 7/16	2 1/4	2 1/4	2 1/8	15/16
8148	8148-D	1 1/2	2 1/4	2 1/4	2 1/8	15/16
-	8150-D	1 9/16	2 1/4	2 3/8	2 1/8	15/16
8152	-	1 5/8	2 3/8	2 1/2	2 1/8	15/16
8160	-	1 7/8	2 1/2	2 3/4	2 5/8	1 1/16
8162	8162-D	1 15/16	2 1/2	2 7/8	2 5/8	1 1/16
8170	-	2 3/16	2 3/4	3 1/4	3 1/4	1 5/16
8172	-	2 1/4	2 3/4	3 1/4	3 1/4	1 5/16
8174	-	2 5/16	2 3/4	3 3/8	3 1/4	1 3/8
8176	-	2 3/8	2 7/8	3 1/2	3 1/4	1 3/8
8180	-	2 1/2	2 7/8	3 3/4	3 1/4	1 3/8
8186	-	2 11/16	3	4	3 1/4	1 1/2
8188	-	2 3/4	3 1/8	4	3 1/4	1 5/8
8190	-	2 13/16	3 1/8	4	3 1/4	1 5/8

6 Point & Double Hex, Thin Wall Standard Length



Part Number 6 Point	Part Number Double Hex	Hex Opening In.	Overall Length (A)	Diameter Nose End (B)	Diameter Drive End (C)	Opening Depth (D)
-	8430-D	15/16	2 1/8	1 7/16	1 7/8	13/16
8432	8432-D	1	2 1/8	1 1/2	1 7/8	13/16
8434	-	1 1/16	2 1/8	1 9/16	1 7/8	13/16
8436	-	1 1/8	2 1/8	1 5/8	1 7/8	13/16
8440	8440-D	1 1/4	2 1/8	1 13/16	2	13/16
8442	8442-D	1 5/16	2 1/8	1 7/8	2	13/16
-	8444-D	1 3/8	2 1/8	1 15/16	2	13/16
8448	8448-D	1 1/2	2 1/4	2 1/8	2 1/8	15/16
8454	-	1 11/16	2 3/8	2 3/8	2 1/8	15/16
8456	-	1 3/4	2 3/8	2 7/16	2 1/8	1 1/16
8458	-	1 13/16	2 1/2	2 9/16	2 1/8	1 1/16
8460	-	1 7/8	2 1/2	2 5/8	2 5/8	1 1/16
8464	-	2	2 5/8	2 3/4	2 5/8	1 3/16
-	-	2 1/8	2 5/8	2 15/16	2 5/8	1 3/16
8472	-	2 1/4	2 3/4	3 1/8	2 5/8	1 5/16
8480	-	2 1/2	2 7/8	3 3/8	3 1/4	1 7/16

BOLDED part numbers are industry popular items and are followed by common variations which may vary in price and availability.

6 Point, Long Length

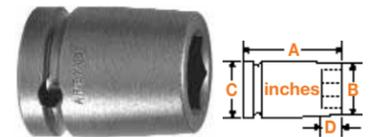

Part Number 6 Point	Hex Opening In.	Overall Length (A)	Diameter Nose End (B)	Diameter Drive End (C)	Opening Depth (D)
8228	7/8	3	1 7/16	2 1/8	9/16
8236	1 1/8	3	1 3/4	2 1/8	3/4
8240	1 1/4	3	2 1/8	2 1/8	13/16

6 Point, Extra Long Length



Part Number 6 Point	Hex Opening In.	Overall Length (A)	Diameter Nose End (B)	Diameter Drive End (C)	Opening Depth (D)
8324	3/4	4 1/4	1 1/4	2 1/8	15/32
8326	13/16	4 1/4	1 3/8	2 1/8	17/32
8332	1	4 1/4	1 9/16	2 1/8	5/8
8336	1 1/8	4 1/4	1 3/4	2 1/8	3/4
8338	1 3/16	4 1/4	1 7/8	2 1/8	3/4
8340	1 1/4	4 1/4	2 1/8	2 1/8	13/16
8342	1 5/16	4 1/4	2 1/8	2 1/8	13/16
8346	1 7/16	4 1/4	2 1/4	2 1/8	15/16
8356	1 3/4	4 1/4	2 5/8	2 5/8	1 1/8
8360	1 7/8	4 1/4	2 3/4	2 5/8	1 1/4
8364	2	4 3/8	2 7/8	2 5/8	1 3/8
8370	2 3/16	4 1/2	3 1/8	2 5/8	1 1/2
8378	2 7/16	4 1/2	3 1/2	3 1/4	1 5/8
8380	2 1/2	4 1/2	3 1/2	3 1/4	1 5/8
8382	2 9/16	4 1/2	3 3/4	3 1/4	1 3/4
8384	2 5/8	4 1/2	3 3/4	3 1/4	1 3/4

6 Point, Thin Wall, Extra Long Length



Part Number 6 Point	Hex Opening In.	Overall Length (A)	Diameter Nose End (B)	Diameter Drive End (C)	Opening Depth (D)
8530	15/16	4 1/4	1 1/2	2 1/8	5/8
8536	1 1/8	4 1/4	1 5/8	2 1/8	3/4
8540	1 1/4	4 1/4	1 13/16	2 1/8	13/16
8542	1 5/16	4 1/4	1 7/8	2 1/8	13/16

1" Sq. Dr. Sockets, SAE

Single Square & Double Square, Standard Length

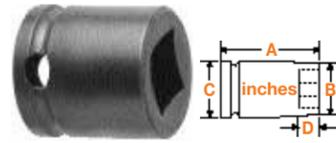

Part No. Single Square	Part No. Double Square	Square Opening In.	Overall Length (A)	Diameter Nose End (B)	Diameter Drive End (C)	Opening Depth (D)
8624	-	3/4	2 1/8	1 5/8	2	13/16
8632	-	1	2 1/8	2 1/8	2 1/8	13/16
8634	-	1 1/16	2 1/8	2 1/8	2 1/8	13/16
8636	-	1 1/8	2 1/4	2 1/4	2 1/8	15/16
8638	8638-D	1 3/16	2 1/4	2 1/4	2 1/8	15/16
8640	8640-D	1 1/4	2 1/4	2 3/8	2 1/8	15/16
8644	-	1 3/8	2 5/16	2 5/8	2 5/8	1
-	8646-D	1 7/16	2 3/8	2 5/8	2 5/8	1
8648	-	1 1/2	2 3/8	2 3/4	2 5/8	1 1/16
-	8652-D	1 5/8	2 1/2	2 7/8	2 5/8	1 1/16

Budd Wheel Sockets

13/16" Square & Combo
13/16" Square 1 1/2" Hex



Part Number	Drive	Overall Length In.	Overall Length mm	Notes
BW-8626	1" Square	2 1/8	54	13/16" Square
BW-848	1" Square	3 3/4	95	Combo. 13/16 Square—1 1/2" Hex
BW-848-F	1" Square	3 3/4	95	Combo. 13/16 Square—1 1/2" Hex for mag. wheels

BOLDED part numbers are industry popular items and are followed by common variations which may vary in price and availability.

1" Sq. Dr. Sockets, Metric

6 Point, Standard Length

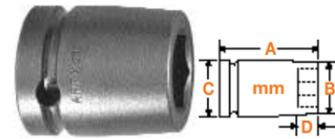

Part Number 6 Point	Hex Opening mm	Overall Length (A)	Diameter Nose End (B)	Diameter Drive End (C)	Opening Depth (D)
21mm18	21	54	34.9	50.8	13.5
24mm18	24	54	38.1	50.8	20.6
27mm18	27	54	42.9	50.8	20.6
29mm18	29	54	47.6	50.8	20.6
30mm18	30	54	50.8	50.8	20.6
30mm48*	30	54	44.4	54.0	20.6
32mm18	32	54	54.0	54.0	20.6
34mm18	34	54	54.0	54.0	20.6
36mm18	36	57	57.1	54.0	23.9
41mm18	41	60	63.5	54.0	23.9
42mm18	42	60	63.5	54.0	23.9
46mm18	46	64	69.8	66.7	26.9
50mm18	50	66	76.2	66.7	30.2

*Thin Wall

6 Point, Long Length



Part Number 6 Point	Hex Opening mm	Overall Length (A)	Diameter Nose End (B)	Diameter Drive End (C)	Opening Depth (D)
24mm38	24	108	38.1	54.0	15.9
27mm38	27	108	41.3	54.0	17.5
28mm38	28	108	44.4	54.0	19.1
33mm38	33	108	54.0	54.0	20.6
36mm38	36	108	54.0	54.0	23.8
37mm38	37	108	57.1	54.0	23.8
46mm38	46	108	69.8	66.7	31.8
50mm38	50	111	73.0	66.7	34.9

1" Sq. Dr. Extensions

2 13/16" to 15" (71mm to 381mm) Length



Part Number	Male Square In.	Type of Lock	Overall Length In.	Overall Length mm
EX-1001	1	9/32 Drill Hole	2 13/16	71
EX-1001-B	1	Ball	2 13/16	71
EX-1003-4	1	9/32 Drill Hole	4	102
EX-1003-B-4	1	Ball	4	102
EX-1003-6	1	9/32 Drill Hole	6	152
EX-1003-B-6	1	Ball	6	152
EX-1003-8	1	9/32 Drill Hole	8	203
EX-1003-B-8	1	Ball	8	203
EX-1003-10	1	9/32 Drill Hole	10	254
EX-1003-B-10	1	Ball	10	254
EX-1003-12	1	9/32 Drill Hole	12	305
EX-1003-B-12	1	Ball	12	305
EX-1003-15	1	9/32 Drill Hole	15	381
EX-1003-B-15	1	Ball	15	381

1" Sq. Dr. Adapters

3/4" to 1 1/2" Male Square



Part Number	Male Square In.	Female Square In.	Type of Lock	Overall Length In.	Overall Length mm
EX-754	3/4	1	7/32 Drill Hole	2 13/16	71
EX-754-B	3/4	1	Ball	2 13/16	71
EX-756-4	3/4	1	7/32 Drill Hole	4	102
EX-756-6	3/4	1	7/32 Drill Hole	6	152
EX-756-8	3/4	1	7/32 Drill Hole	8	203
EX-1101	1 1/2	1	3/8 Drill Hole	3 9/16	91

1" Sq. Dr. Universal Adapters

3/4" to 1" Male Square



Part Number	Male Sq. In.	Female Sq. In.	Type of Lock	Overall Length In.	Overall Length mm	Largest Diameter In.	Largest Diameter mm
MF-77B	3/4	1	Ball	4 3/4	121	2	51
MF-82	1	1	9/32 Drill Hole	5	127	2	51
MF-82B	1	1	Ball	5	127	2	51

Universal wrenches must not be used with impact drivers. Maximum operating angle is 30°.

BOLDED part numbers are industry popular items and are followed by common variations which may vary in price and availability.

1 1/2" Sq. Dr. Sockets, SAE

6 Point, Standard Length

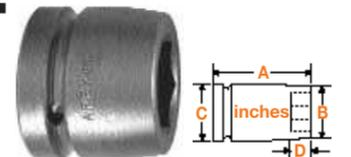

Part Number 6 Point	Hex Opening In.	Overall Length (A)	Diameter Nose End (B)	Diameter Drive End (C)	Opening Depth (D)
9172	2 1/4	3 1/4	3 3/8	3 1/4	1 1/2

Additional sizes available upon request.

1 1/2" Sq. Dr. Adapters

1" Male Square



Part Number	Male Square In.	Female Square In.	Type of Lock	Overall Length In.	Overall Length mm
EX-1005	1	1 1/2	9/32 Drill Hole	3 15/16	100
EX-1005-B	1	1 1/2	Ball	3 15/16	100

2 1/2" Sq. Dr. Sockets, SAE

6 Point, Standard Length

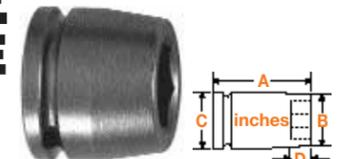

Part Number 6 Point	Hex Opening In.	Overall Length (A)	Diameter Nose End (B)	Diameter Drive End (C)	Opening Depth (D)
01112	3 1/2	4 3/4	5 1/2	5 1/2	2 1/2

Additional sizes available upon request.

If the tool you need does not appear in this catalog, give us a call. The odds are, we may have what you need as a non-catalog item. If not, our experienced staff of tooling experts can design and manufacture "specials" to meet the needs of your specific application. Give us a call at 1-800-845-5629 or visit our website www.apex-tools.com.

APEX Guard™

USING TUFFlex TECHNOLOGY

Quality Anti-Mar Fastener Tools Begin With Quality Fastener Tools.

Apex **μ-Guard** using TUFFlex® technology provides a protective barrier between genuine Apex fastener tools and your finely finished workpiece. The free-spinning patent-pending design provides maximum protection for polished and highly sensitive surfaces.

Apex **μ-Guard** covering is made of a thermo plastic urethane (TPU elastomer) which cushions against costly incidental side impacts. It offers the lowest coefficient of friction for maximum tool efficiency. It is also non-removable for tamper resistance.

With Apex **μ-Guard** you get the proven Apex fastener tool fit and performance plus the best protection available against marring and in-system damage. **μ-Guard** is your guard against the potential hazards caused by rotational friction.

Prevents Side Impact Damage



Free-Spinning Design



Virtually Damage Free



If it doesn't say Apex on the outside, how can you be sure of what's on the inside?

Why Apex **μ-Guard** Anti-Mar Fastener Tools Are The Best Choice

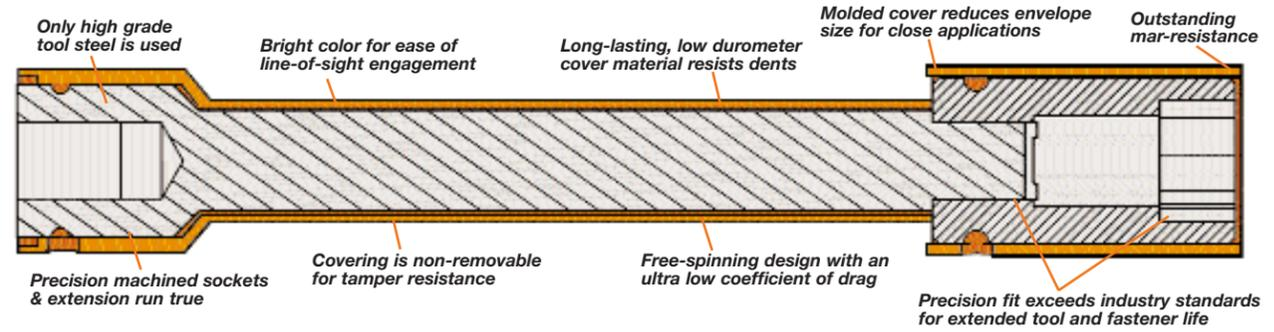

Quality Apex Tools Under The Cover

- Apex fastener tools are made from only tool grade steel then heat treated using our proprietary process for the proper hardness based on the application. Not too brittle to break nor too soft to wear out after one shift.
- Each core tool is then machined for a precision fit that exceeds industry standards. Improper fit can lead to premature fastener and fastener tool failure.
- Apex fastener tools run true with minimal wobble for more efficient fastening cycles.

The Cover Story

- A low durometer cover material that resists dents during incidental side impacts. Only Apex **μ-Guard** absorbs side impacts and does not produce raised burrs when impacted.
- Cover is molded to the tool for reduced envelope dimensions yet still is able to exhibit "free-spinning" capability for improved ergonomics and safety. No other competitor has this capability. Some competitors even require their core tool be modified in order to assemble the cover resulting in weaker integrity and premature failure.
- Covering is non-removable to prevent unwanted tampering on the line.
- Low coefficient of friction between the cover and the tool produces minimal loss of tool efficiency.
- Bright color of covering makes fastener contact visually easier shift after shift and station monitoring quick and easy.
- Part numbers are clearly marked for ease of identification.
- Only Apex has the manufacturing capability, inventory and global supply network to supply the global requirements of today's marketplace.

μ-Guard Sockets
(Includes socket and cover)



Part Number	Socket	Drive End			Socket Length	Fastener End			Assembly Features*
		Size	Type	Sex		Size	Type	Sex	
UGS-AB710	10MM21	1/4	Square	F	standard	10 mm	Hex	F	FS
UGS-AB710-01	M-10MM21	1/4	Square	F	standard	10 mm	Hex	F	FS, M
UGS-AB710-02	MB-10MM21	1/4	Square	F	standard	10 mm	Hex	F	FS, M, B
UGS-BA610	10MM13	3/8	Square	F	standard	10 mm	Hex	F	FS
UGS-BA610-01	M-10MM13	3/8	Square	F	standard	10 mm	Hex	F	FS, M
UGS-BB710	10MM23	3/8	Square	F	long	10 mm	Hex	F	FS
UGS-BB710-01	M-10MM23	3/8	Square	F	long	10 mm	Hex	F	FS, M
UGS-BB710-02	MB-10MM23	3/8	Square	F	long	10 mm	Hex	F	FS, M, B
UGS-BB713	13MM23	3/8	Square	F	long	13 mm	Hex	F	FS
UGS-BB713-01	M-13MM23	3/8	Square	F	long	13 mm	Hex	F	FS, M
UGS-BB713-02	MB-13MM23	3/8	Square	F	long	13 mm	Hex	F	FS, M, B
UGS-CB713	13MM25	1/2	Square	F	long	13 mm	Hex	F	FS
UGS-CB713-03	SF-13MM25	1/2	Square	F	long	13 mm	Hex	F	FS, SF
UGS-CB715	15MM25	1/2	Square	F	long	15 mm	Hex	F	FS
UGS-CB715-03	SF-15MM25	1/2	Square	F	long	15 mm	Hex	F	FS, SF
UGS-CB718	18MM25	1/2	Square	F	long	18 mm	Hex	F	FS
UGS-CB718-03	SF-18MM25	1/2	Square	F	long	18 mm	Hex	F	FS, SF



If your tool is not shown in the table of representative products above, please contact your Apex representative.

μ-Guard Extensions
(Includes extension and cover)



Part Number	Extension	Drive End			Extension Length	Socket End			Assembly Features*
		Size	Type	Sex		Size	Type	Sex	
UGE-A2A	EX-250-2	1/4	Hex	M	2	1/4	Square	M	FS
UGE-A4A	EX-250-4	1/4	Hex	M	4	1/4	Square	M	FS
UGE-A6A	EX-250-6	1/4	Hex	M	6	1/4	Square	M	FS
UGE-B2A	EX-370-2	1/4	Hex	M	2	3/8	Square	M	FS
UGE-B4A	EX-370-4	1/4	Hex	M	4	3/8	Square	M	FS
UGE-B6A	EX-370-6	1/4	Hex	M	6	3/8	Square	M	FS
UGE-B3C	EX-376-3	3/8	Square	F	3	3/8	Square	M	FS
UGE-B6C	EX-376-6	3/8	Square	F	6	3/8	Square	M	FS
UGE-B12C	EX-376-12	3/8	Square	F	12	3/8	Square	M	FS
UGE-C4C	EX-508-4	1/2	Square	F	4	1/2	Square	M	FS
UGE-C8C	EX-508-8	1/2	Square	F	8	1/2	Square	M	FS
UGE-C12C	EX-508-12	1/2	Square	F	12	1/2	Square	M	FS



If your tool is not shown in the table of representative products above, please contact your Apex representative.

μ-Guard Bit Holders
(Includes bit holder and cover)



Part Number	Bit Holder	Drive End			Holder Length	Fastener End			Assembly Features*
		Size	Type	Sex		Size	Type	Sex	
UGH-1NAA	M-490	1/4	Hex	M	2 31/32	1/4	Hex	F	FS, M, ET
UGH-1AAA	M-490-2	1/4	Hex	M	2	1/4	Hex	F	FS, M, ET
UGH-2NBG	838	3/8	Square	F	1 1/2	1/4	Hex	F	FS, ET
UGH-1NBG	M-838	3/8	Square	F	2 5/8	1/4	Hex	F	FS, M, ET
UGH-2NBC	835	3/8	Square	F	1 1/2	5/16	Hex	F	FS, ET
UGH-1NBC	M-835	3/8	Square	F	2 3/4	5/16	Hex	F	FS, M, ET
UGH-2NBD	855	1/2	Square	F	1 1/2	5/16	Hex	F	FS, ET
UGH-1NBD	M-855	1/2	Square	F	2 3/4	5/16	Hex	F	FS, M, ET
UGH-2NCK	QR-308	3/8	Square	F	1 3/4	1/4	Hex	F	FS, QR
UGH-2NCF	QR-508	1/2	Square	F	2 1/8	1/4	Hex	F	FS, QR
UGH-2NCJ	QR-314	3/8	Square	F	2	7/16	Hex	F	FS, QR
UGH-2NCL	QR-514	1/2	Square	F	2 1/8	7/16	Hex	F	FS, QR



If your tool is not shown in the table of representative products above, please contact your Apex representative.

***Features Abbreviations**
FS Free Spinning Tool is able to rotate independently of Cover
M Magnetic Tool includes magnet to hold the position of the fastener during fastening operation
B Bolt Clearance Tool is spring-loaded to allow the bolt or nut to retract into the socket body
SF Surface Drive Tool has radiused corners to allow easier alignment and engagement of fastener
ET Exposed Tip Cover extends beyond end of Bit Holder to shield the majority of a standard 1 inch long Insert Bit.
QR Quick Release Tip of Insert Bit will not be covered to allow for easier fastener engagement. Tool has tension feature to allow quick & easy change between power bits
Notes: Reported lengths are based on uncovered tool length only for reference. Cover may extend beyond end of tool by 2 mm unless otherwise noted.

Don't see what you need?

This catalog contains 3,000+ of the most frequently requested bits, sockets and fastening accessories. Our entire active offering approaches 10,000 sellable part numbers. If the tool you need does not appear in this catalog, give us a call. The odds are, we may have what you need as a non-catalog item. If not, our experienced staff of tooling experts can design and manufacture "specials" to meet the needs of your specific applications.

This flexibility has helped make Apex the only manufacturer which is a market and technology leader in all of the following industrial product categories: Bits & Bit Holders, Impact Sockets, Extensions and Universal Wrenches.



Get a quote on-line fast!

You can even specify custom tooling on-line fast! Specification sheets for bits, sockets, extensions and

universal joints are available on-line. Just complete the appropriate easy to use form and submit your request. You'll receive a rapid response from one of our experienced staff of tooling experts.



Easy to complete forms are available on-line at our website www.apex-tools.com.

If the tool you need does not appear in this catalog, give us a call. The odds are, we may have what you need as a non-catalog item. If not, our experienced staff of tooling experts can design and manufacture "specials" to meet the needs of your specific applications.



Apex FreeSpin Covers

For Durability and Protection.

Reduce Costly "Re-Works"

Apex FreeSpin anti-mar cover assemblies protect painted, plated, polished or critical surfaces from direct incidental contact with sockets and extensions. With Apex FreeSpin covers, damage caused by marring is greatly reduced.

Low-Cost Durable Protection

Apex FreeSpin anti-mar covers are the most economical protection you can get. The durable nylon construction provides many cycles of protection, shift after shift.

Popular Sizes Are Available Now!

All Apex FreeSpin anti-mar cover assemblies on the adjacent charts are available for quick delivery.

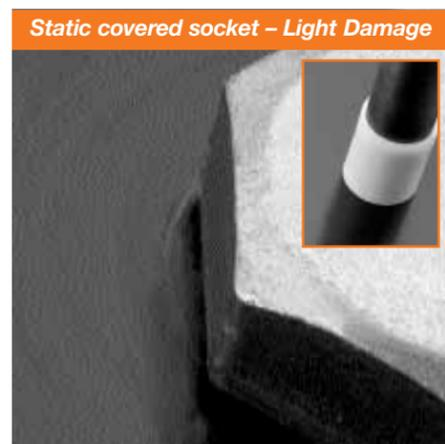

Simple Design Installs In Seconds!

Apex FreeSpin covers can be installed in seconds. No special trips to the tool crib are required.

Male Drive End Assembly*



*For best results, Apex recommends using our optional installation tool for installing the retaining ring. See page 70.

Female Drive End Assembly



How to use the Tables below:

Socket Cover Example

You need a Cover that fits Socket Part # M-10MM13

- From your Apex catalog or by measuring part:
 - Drive End Diameter = 19.1 mm
 - Overall Length = 31.8 mm
 - Hex Opening = 10 mm
- Match your "Drive End Diameter" then "Socket Length" with those listed in the **Free-Spin Covers For Sockets** table below.
- Find "Cover Part #" where your "Hex Opening" fits within "Min & Max Hex Size" values.

Use Cover Part # **NCS0752B1252C** (shown in orange below).

Socket with Extension Cover Example

You need a Cover that fits Socket part # 8MM11 and Extension part # EX-255

- From your Apex catalog or by measuring part:
 - Extension Length = 8 inches
 - Drive End Diameter = 12.7 mm
 - Overall Length = 25.4 mm
- Find the group of "Cover Assy Part #s" that fit your "Extension Part #" from the **Covers For Sockets with Extensions** table below.
- Select the "Cover Assy Part #" that matches your "Drive End Diameter" and "Socket Length".
- Replace the **XX** in the "Cover Assy. Part #" with your 2-digit Extension Length (available lengths are listed under "Extension Length").

Use Cover Assy. Part # **NCEB08F-S0500-1000** (shown in orange below).

Free-Spin Covers For Sockets

Cover Part Number	Fits Hex Socket with these Outer Dimensions**							
	Drive End Diameter		Socket Length		Min Hex Size*		Max Hex Size*	
	(inch)	(mm)	(inch)	(mm)	(inch)	(mm)	(inch)	(mm)
1/4" Drive								
NCS0500A0875A	0.500	12.7	0.875	22.2		3.5		4.0
NCS0500A0875B	0.500	12.7	0.875	22.2		4.5		5.0
NCS0500A0875C	0.500	12.7	0.875	22.2		5.5	1/4	
NCS0500A0875D	0.500	12.7	0.875	22.2	1/4		9/32	
NCS0500A0875E	0.500	12.7	0.875	22.2	5/16		5/16	
NCS0500A1000A	0.500	12.7	1.000	25.4	E-4		E-5	
NCS0500A1000B	0.500	12.7	1.000	25.4	E-6		E-6	
NCS0500A1000C	0.500	12.7	1.000	25.4	9/32		E-8	
NCS0500A1000D	0.500	12.7	1.000	25.4		8.0	11/32	
NCS0500A1750A	0.500	12.7	1.750	44.5	3/16		1/4	
NCS0500A1750B	0.500	12.7	1.750	44.5		7.0	9/32	
NCS0500A1750C	0.500	12.7	1.750	44.5	5/16		8.0	
NCS0563A1000A	0.563	14.3	1.000	25.4	11/32		10.0	
NCS0626A1000A	0.626	15.9	1.000	25.4	3/8		7/16	
NCS0626A1750A	0.626	15.9	1.750	44.5		10.0	7/16	
3/8" Drive								
NCS0752B0875A	0.752	19.1	0.875	22.2		7.0	5/16	
NCS0752B0875B	0.752	19.1	0.875	22.2		9.0	7/16	
NCS0752B0875C	0.752	19.1	0.875	22.2		12.0		12
NCS0752B1252A	0.752	19.1	1.252	31.8	3/16		6.0	
NCS0752B1252B	0.752	19.1	1.252	31.8		6.0	9.0	
NCS0752B1252C	0.752	19.1	1.252	31.8		9.0	11.0	
NCS0752B1252D	0.752	19.1	1.252	31.8	7/16		12.0	
NCS0752B1500A	0.752	19.1	1.500	38.1	7/32		9/32	
NCS0752B1500B	0.752	19.1	1.500	38.1	3/8		12.0	
NCS0752B1500C	0.752	19.1	1.500	38.1	15/32		9/16	
NCS0752B2000A	0.752	19.1	2.000	50.8		6.0	11/32	

* "E" designation (i.e. E-8) stands for the point size of a Torx socket
 ** Socket must have a ring groove. Sockets that do not have ring grooves are noted as such in the catalog.
 • Straight socket (ie. Non-tapered.)

Cover Part Number	Fits Hex Socket with these Outer Dimensions**							
	Drive End Diameter		Socket Length		Min Hex Size*		Max Hex Size*	
	(inch)	(mm)	(inch)	(mm)	(inch)	(mm)	(inch)	(mm)
NCS0752B2000B	0.752	19.1	2.000	50.8		9.0	3/8	
NCS0752B2000C	0.752	19.1	2.000	50.8		12.0	1/2	
NCS0813B0875A	0.813	20.7	0.875	22.2	1/2			13.0
NCS0813B1500A	0.813	20.7	1.500	38.1		14	9/16	
NCS0813B1500B	0.813	20.7	1.500	38.1	1/2			15
NCS0813B2000A	0.813	20.7	2.000	50.8	1/2		9/16	
NCS0813B3500A	0.813	20.7	3.500	88.9	1/2			13.0
NCS0875B1500A	0.875	22.2	1.500	38.1		14.0		16.0
NCS0875B2000A	0.875	22.2	2.000	50.8		14.0		15.0
1/2" Drive								
NCS0938C1500A	0.938	23.8	1.500	38.1	1/4		11/32	
NCS0938C1500B	0.938	23.8	1.500	38.1	5/16			12.0
NCS0938C1500C	0.938	23.8	1.500	38.1		12.0	9/16	
NCS0938C1500D	0.938	23.8	1.500	38.1	1/2			17.0
NCS0938C2250A	0.938	23.8	2.250	57.2	5/16			10.0
NCS0938C2250B	0.938	23.8	2.250	57.2		11.0	9/16	
NCS0938C2250C	0.938	23.8	2.250	57.2		15.0		15.0
NCS0938C3250A	0.938	23.8	3.250	82.6	5/16			10.0
NCS0938C3250B	0.938	23.8	3.250	82.6		10.0		13.0
NCS0938C3250C	0.938	23.8	3.250	82.6		13.0		16.0
NCS0938C3250D	0.938	23.8	3.250	82.6		15.0	11/16	
NCS1000C1500A	1.000	25.4	1.500	38.1	E-10			E-12
NCS1000C1500B	1.000	25.4	1.500	38.1	E-14			E-16
NCS1000C1500C	1.000	25.4	1.500	38.1	5/8			5/8
NCS1000C1500D	1.000	25.4	1.500	38.1	1/2			18
NCS1126C1500A	1.126	28.6	1.500	38.1	3/4			20.0
NCS1126C1500B	1.126	28.6	1.500	38.1	9/16			21.0
NCS1126C2250A	1.126	28.6	2.250	57.2		17.0	3/4	

Free-Spin Cover Assemblies For Sockets with Extensions

Cover Assembly Part Number	Extension Part Number	Drive Size	Ext. Type	Extension Length (inches)*	Fits any socket with these 2 outer dimensions			
					Socket Drive End Diameter		Socket Overall Length	
					(inch)	(mm)	(inch)	(mm)
NCEAXXM-S0500-0875	EX-250-XX or EX-250-B-XX	1/4"	Male	XX = 3, 4, 6, 8 or 12	0.500	12.7	0.875	22.2
NCEAXXM-S0500-1000	EX-250-XX or EX-250-B-XX	1/4"	Male	XX = 3, 4, 6, 8 or 12	0.500	12.7	1.000	25.4
NCEAXXM-S0500-1750	EX-250-XX or EX-250-B-XX	1/4"	Male	XX = 3, 4, 6, 8 or 12	0.500	12.7	1.750	44.5
NCEAXXM-S0563-1000	EX-250-XX or EX-250-B-XX	1/4"	Male	XX = 3, 4, 6, 8 or 12	0.563	14.3	1.000	25.4
NCEAXXM-S0626-1000	EX-250-XX or EX-250-B-XX	1/4"	Male	XX = 3, 4, 6, 8 or 12	0.626	15.9	1.000	25.4
NCEAXXM-S0626-1750	EX-250-XX or EX-250-B-XX	1/4"	Male	XX = 3, 4, 6, 8 or 12	0.626	15.9	1.750	44.5
NCEBXXF-S0500-0875	EX-255-XX or EX-255-B-XX	1/4"	Female	XX = 2, 3, 4, 6, 8, 10 or 12	0.500	12.7	0.875	22.2
NCEBXXF-S0500-1000	EX-255-XX or EX-255-B-XX	1/4"	Female	XX = 2, 3, 4, 6, 8, 10 or 12	0.500	12.7	1.000	25.4
NCEBXXF-S0500-1750	EX-255-XX or EX-255-B-XX	1/4"	Female	XX = 2, 3, 4, 6, 8, 10 or 12	0.500	12.7	1.750	44.5

* XX suffix on Extension P/N is a whole number indicating the length in inches of the extension.
 In some cases this designation is left off of the end of the extension P/N indicating that it is the shortest length capable of being manufactured.
 For Extension lengths shorter than those listed, a Socket Only cover would be used.

(Continued on next page)

Covers For Sockets with Extensions (continued)

Cover Assembly Part Number	Extension Part Number	Drive Size	Ext. Type	Extension Length (inches)*	Fits any socket with these 2 outer dimensions			
					Socket Drive End Diameter		Socket Overall Length	
					(inch)	(mm)	(inch)	(mm)
NCEAXXM-S0500-0875	EX-250-XX or EX-250-B-XX	1/4"	Male	XX = 3, 4, 6, 8 or 12	0.500	12.7	0.875	22.2
NCEAXXM-S0500-1000	EX-250-XX or EX-250-B-XX	1/4"	Male	XX = 3, 4, 6, 8 or 12	0.500	12.7	1.000	25.4
NCEAXXM-S0500-1750	EX-250-XX or EX-250-B-XX	1/4"	Male	XX = 3, 4, 6, 8 or 12	0.500	12.7	1.750	44.5
NCEAXXM-S0563-1000	EX-250-XX or EX-250-B-XX	1/4"	Male	XX = 3, 4, 6, 8 or 12	0.563	14.3	1.000	25.4
NCEAXXM-S0626-1000	EX-250-XX or EX-250-B-XX	1/4"	Male	XX = 3, 4, 6, 8 or 12	0.626	15.9	1.000	25.4
NCEAXXM-S0626-1750	EX-250-XX or EX-250-B-XX	1/4"	Male	XX = 3, 4, 6, 8 or 12	0.626	15.9	1.750	44.5
NCEBXXF-S0500-0875	EX-255-XX or EX-255-B-XX	1/4"	Female	XX = 2, 3, 4, 6, 8, 10 or 12	0.500	12.7	0.875	22.2
NCEBXXF-S0500-1000	EX-255-XX or EX-255-B-XX	1/4"	Female	XX = 2, 3, 4, 6, 8, 10 or 12	0.500	12.7	1.000	25.4
NCEBXXF-S0500-1750	EX-255-XX or EX-255-B-XX	1/4"	Female	XX = 2, 3, 4, 6, 8, 10 or 12	0.500	12.7	1.750	44.5
NCEBXXF-S0563-1000	EX-255-XX or EX-255-B-XX	1/4"	Female	XX = 2, 3, 4, 6, 8, 10 or 12	0.563	14.3	1.000	25.4
NCEBXXF-S0626-1000	EX-255-XX or EX-255-B-XX	1/4"	Female	XX = 2, 3, 4, 6, 8, 10 or 12	0.626	15.9	1.000	25.4
NCEBXXF-S0626-1750	EX-255-XX or EX-255-B-XX	1/4"	Female	XX = 2, 3, 4, 6, 8, 10 or 12	0.626	15.9	1.750	44.5
NCEJXXM-S0625-1250	EX-370-XX or EX-370-B-XX	1/4"	Male	XX = 4, 6, 8 or 10	0.625	15.9	1.250	31.8
NCEJXXM-S0752-0875	EX-370-XX or EX-370-B-XX	1/4"	Male	XX = 4, 6, 8 or 10	0.752	19.1	0.875	22.2
NCEJXXM-S0752-1252	EX-370-XX or EX-370-B-XX	1/4"	Male	XX = 4, 6, 8 or 10	0.752	19.1	1.252	31.8
NCEJXXM-S0752-1500	EX-370-XX or EX-370-B-XX	1/4"	Male	XX = 4, 6, 8 or 10	0.752	19.1	1.500	38.1
NCEJXXM-S0752-2000	EX-370-XX or EX-370-B-XX	1/4"	Male	XX = 4, 6, 8 or 10	0.752	19.1	2.000	50.8
NCEJXXM-S0813-0875	EX-370-XX or EX-370-B-XX	1/4"	Male	XX = 4, 6, 8 or 10	0.813	20.7	0.875	22.2
NCEJXXM-S0813-1500	EX-370-XX or EX-370-B-XX	1/4"	Male	XX = 4, 6, 8 or 10	0.813	20.7	1.500	38.1
NCEJXXM-S0813-2000	EX-370-XX or EX-370-B-XX	1/4"	Male	XX = 4, 6, 8 or 10	0.813	20.7	2.000	50.8
NCEJXXM-S0813-3500	EX-370-XX or EX-370-B-XX	1/4"	Male	XX = 4, 6, 8 or 10	0.813	20.7	3.500	88.9
NCEJXXM-S0875-1500	EX-370-XX or EX-370-B-XX	1/4"	Male	XX = 4, 6, 8 or 10	0.875	22.2	1.500	38.1
NCEJXXM-S0875-2000	EX-370-XX or EX-370-B-XX	1/4"	Male	XX = 4, 6, 8 or 10	0.875	22.2	2.000	50.8
NCEKXXM-S0625-1250	EX-371-XX or EX-371-B-XX	7/16"	Male	XX = 6, 8 or 10	0.625	15.9	1.250	31.8
NCEKXXM-S0752-0875	EX-371-XX or EX-371-B-XX	7/16"	Male	XX = 6, 8 or 10	0.752	19.1	0.875	22.2
NCEKXXM-S0752-1252	EX-371-XX or EX-371-B-XX	7/16"	Male	XX = 6, 8 or 10	0.752	19.1	1.252	31.8
NCEKXXM-S0752-1500	EX-371-XX or EX-371-B-XX	7/16"	Male	XX = 6, 8 or 10	0.752	19.1	1.500	38.1
NCEKXXM-S0752-2000	EX-371-XX or EX-371-B-XX	7/16"	Male	XX = 6, 8 or 10	0.752	19.1	2.000	50.8
NCEKXXM-S0813-0875	EX-371-XX or EX-371-B-XX	7/16"	Male	XX = 6, 8 or 10	0.813	20.7	0.875	22.2
NCEKXXM-S0813-1500	EX-371-XX or EX-371-B-XX	7/16"	Male	XX = 6, 8 or 10	0.813	20.7	1.500	38.1
NCEKXXM-S0813-2000	EX-371-XX or EX-371-B-XX	7/16"	Male	XX = 6, 8 or 10	0.813	20.7	2.000	50.8
NCEKXXM-S0813-3500	EX-371-XX or EX-371-B-XX	7/16"	Male	XX = 6, 8 or 10	0.813	20.7	3.500	88.9
NCEKXXM-S0875-1500	EX-371-XX or EX-371-B-XX	7/16"	Male	XX = 6, 8 or 10	0.875	22.2	1.500	38.1
NCEKXXM-S0875-2000	EX-371-XX or EX-371-B-XX	7/16"	Male	XX = 6, 8 or 10	0.875	22.2	2.000	50.8
NCEMXXF-S0625-1250	EX-376-XX or EX-376-B-XX	3/8"	Female	XX = 3, 4, 5, 6, 8, 10, 12, 15 or 18	0.625	15.9	1.250	31.8
NCEMXXF-S0752-0875	EX-376-XX or EX-376-B-XX	3/8"	Female	XX = 3, 4, 5, 6, 8, 10, 12, 15 or 18	0.752	19.1	0.875	22.2
NCEMXXF-S0752-1252	EX-376-XX or EX-376-B-XX	3/8"	Female	XX = 3, 4, 5, 6, 8, 10, 12, 15 or 18	0.752	19.1	1.252	31.8
NCEMXXF-S0752-1500	EX-376-XX or EX-376-B-XX	3/8"	Female	XX = 3, 4, 5, 6, 8, 10, 12, 15 or 18	0.752	19.1	1.500	38.1
NCEMXXF-S0752-2000	EX-376-XX or EX-376-B-XX	3/8"	Female	XX = 3, 4, 5, 6, 8, 10, 12, 15 or 18	0.752	19.1	2.000	50.8
NCEMXXF-S0813-0875	EX-376-XX or EX-376-B-XX	3/8"	Female	XX = 3, 4, 5, 6, 8, 10, 12, 15 or 18	0.813	20.7	0.875	22.2
NCEMXXF-S0813-1500	EX-376-XX or EX-376-B-XX	3/8"	Female	XX = 3, 4, 5, 6, 8, 10, 12, 15 or 18	0.813	20.7	1.500	38.1
NCEMXXF-S0813-2000	EX-376-XX or EX-376-B-XX	3/8"	Female	XX = 3, 4, 5, 6, 8, 10, 12, 15 or 18	0.813	20.7	2.000	50.8
NCEMXXF-S0813-3500	EX-376-XX or EX-376-B-XX	3/8"	Female	XX = 3, 4, 5, 6, 8, 10, 12, 15 or 18	0.813	20.7	3.500	88.9
NCEMXXF-S0875-1500	EX-376-XX or EX-376-B-XX	3/8"	Female	XX = 3, 4, 5, 6, 8, 10, 12, 15 or 18	0.875	22.2	1.500	38.1
NCEMXXF-S0875-2000	EX-376-XX or EX-376-B-XX	3/8"	Female	XX = 3, 4, 5, 6, 8, 10, 12, 15 or 18	0.875	22.2	2.000	50.8
NCEUXXF-S0938-1500	EX-508-XX or EX-508-B-XX	1/2"	Female	XX = 3, 4, 5, 6, 8, 10, 12, 15 or 18	0.938	23.8	1.500	38.1
NCEUXXF-S0938-2250	EX-508-XX or EX-508-B-XX	1/2"	Female	XX = 3, 4, 5, 6, 8, 10, 12, 15 or 18	0.938	23.8	2.250	57.2
NCEUXXF-S0938-3250	EX-508-XX or EX-508-B-XX	1/2"	Female	XX = 3, 4, 5, 6, 8, 10, 12, 15 or 18	0.938	23.8	3.250	82.6
NCEUXXF-S1000-1500	EX-508-XX or EX-508-B-XX	1/2"	Female	XX = 3, 4, 5, 6, 8, 10, 12, 15 or 18	1.000	25.4	1.500	38.1
NCEUXXF-S1126-1500	EX-508-XX or EX-508-B-XX	1/2"	Female	XX = 3, 4, 5, 6, 8, 10, 12, 15 or 18	1.126	28.6	1.500	38.1
NCEUXXF-S1126-2250	EX-508-XX or EX-508-B-XX	1/2"	Female	XX = 3, 4, 5, 6, 8, 10, 12, 15 or 18	1.126	28.6	2.250	57.2

* XX suffix on Extension PIN is a whole number indicating the length in inches of the extension. In some cases this designation is left off of the end of the extension PIN indicating that it is the shortest length capable of being manufactured. For Extension lengths shorter than those listed, a Socket Only cover would be used.

Free-Spin Cover Installation Tool

Installation tool ensures proper positioning of the retaining ring on extensions with male drive end.

Part Number	Used on Covers with Part # Prefix
543805	NCEA, NCEJ, NCEK



Don't see what you need?

This catalog contains 3,000+ of the most frequently requested bits, sockets and fastening accessories. Our entire active offering approaches 10,000 sellable part numbers. If the tool you need does not appear in this catalog, give us a call. The odds are, we may have what you need as a non-catalog item. If not, our experienced staff of tooling experts can design and manufacture "specials" to meet the needs of your specific applications.

This flexibility has helped make Apex the only manufacturer which is a market and technology leader in all of the following industrial product categories: Bits & Bit Holders, Impact Sockets, Extensions and Universal Wrenches.

Get a quote on-line fast!

You can even specify custom tooling on-line fast! Specification sheets for bits, sockets, extensions and



universal joints are available on-line. Just complete the appropriate easy to use form and submit your request. You'll receive a rapid response from one of our experienced staff of tooling experts.

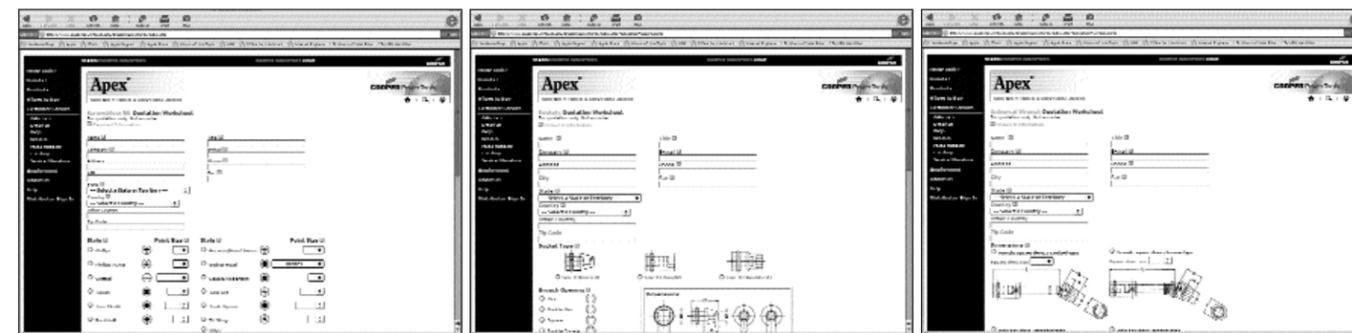

Easy to complete forms are available on-line at our website www.apex-tools.com.

If the tool you need does not appear in this catalog, give us a call. The odds are, we may have what you need as a non-catalog item. If not, our experienced staff of tooling experts can design and manufacture "specials" to meet the needs of your specific applications.



Apex® Has A Wide Selection Of Custom Designed Anti-Mar Covers.

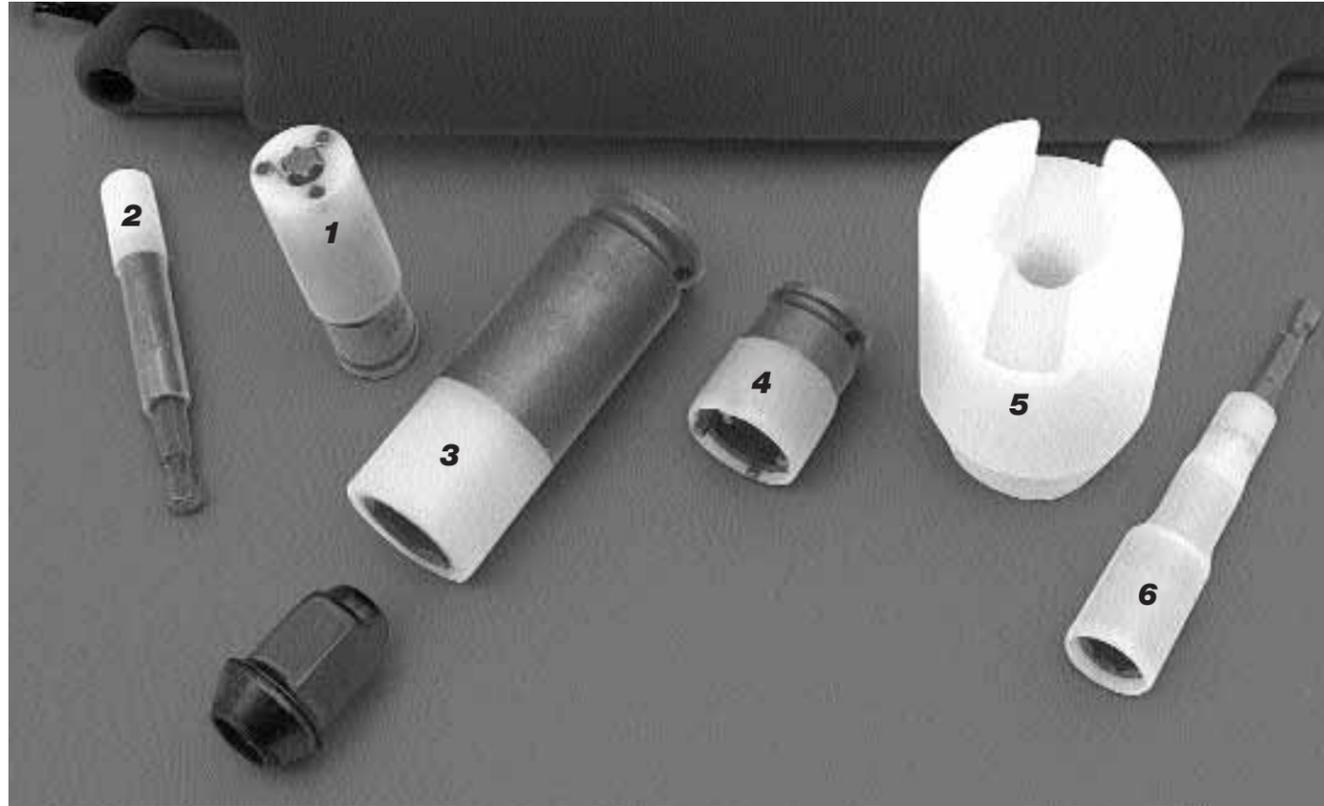

Over Half A Century Of Quality In Every Design

For many years Apex has been producing protective covers for our quality products. Each was custom designed by our staff of engineers to work in a specific application. Over time we have developed a vast library of designs that work not only for their original applications but may also be a solution for one of your applications.



Our covered product designs include sockets, sockets and extensions, bits and bit holders, nutsetters and many more.

Each design was developed with one or more of the following unique features and capabilities:

- Free-spinning covers which allow the tool to rotate independently of the cover for improved protection of sensitive surfaces.
- Spring-loaded covers which retract when engaging the fastener.
- Embedded magnets in covers increase holding force on fastener.
- Single-piece construction to reduce material interfaces.
- Press fit/non-free-spinning for reduced envelope size in tight clearance applications.

Apex recognizes the need in assembly operations for the protection of painted or finished surfaces. We can coat just about any Apex bit or socket with a protective nylon sleeve. Shown above are some recently manufactured solutions with a brief description of the application.

- 1. Pick-up Truck Tailgate to Bed**
Torx® T-45 Bit with magnets within the sleeve to secure fastener.
- 2. Sun Visor Installation**
Phillips bit used with magnetic bit holder. Nylon sleeve reduces headliner and visor damage.
- 3. Lug Nut Assembly**
Magnetic 19MM socket has nylon coating to protect chrome plated and polished aluminum wheels.
- 4. Antenna Driver**
Four-prong antenna bezel nutdriver with nylon sleeve to reduce damage to painted surface.
- 5. Spare Tire Wing Nut Assembly**
All nylon socket to install low torque wing nut.
- 6. Painted Door Assembly**
Only the nutsetter spins within the nylon sleeve, eliminating any mark on surface around the fastener. Nylon sleeve also protects adjacent painted door surface.

How to use this guide:

1. Scan the desired category of product for Assembly Part Numbers that meet your criteria using chart to explain abbreviations.
2. Contact your local Apex representative to confirm suitability and provide pricing.
3. Fill out either the Bit Worksheet or the Socket Quotation Worksheet located in the back of this brochure and fax to your local Apex representative, if your requirements dictate a product not found in the tables that follow.

*Features Abbreviations	ER Embedded Rare Earth Magnets	LC Limited Clearance	R Rare Earth Magnet	SF Surface Drive
B Bolt Clearance	ET Exposed Tip	M Magnetic	RE Retractable / Finder Sleeve	SM Strip Magnet
DM Donut Magnet	FL Fast Lead	P Pinned	RNT Removable Nylon Tip	TD Turned OD
EC Extension Cover Only	FS Free Spinning	PC Partially Covered	RT Recessed Tip	U Universal (Swivel)
EM Embedded Magnets	FT Flush to Tip	PF Press Fit	SB Shallow Broach	

Covered Power Bit Complete Assemblies (Includes Tool and Anti-Mar Cover)

Complete Assembly Ordering Number	Bit				Cover Features*
	Type	Drive Size	Pt. Size	Length (in.)	
SD-5211	Phillips	1/4	2	1 15/16	ET PF
SD-4462-3	Phillips	1/4	3	3.5	RE RT RNT
SD-5349	Phillips	1/4	3	3.5	RE RT (for 0.41" dia fastener head)
SD-5346-K	Torx	7/16	45	3.5	RE RT (for 0.56" dia fastener head)
SD-5346-N	Torx	7/16	45	3.5	RE RT (for 0.66" dia fastener head)
SD-5370	Torx	7/16	50	3.5	PF RT (for 1.12" dia fastener head)
SD-5362	Hex	1/4	5 mm	4	PF R
SD-5362-6	Hex	1/4	5 mm	6	PF RT

Covered Insert Bit & Bit Holder Complete Assemblies (Includes Tool and Anti-Mar Cover)

Complete Assembly Ordering Number	Holder					Bit					Cover Features*
	Drive Size	Drive Type	Sex	Length (in.)	Features*	Type	Drive Size	Pt. Size	Length (in.)	Features*	
SD-5306	1/4	Hex	M	2 31/32	M	Phillips	1/4	1	1	LC	EM FS RT
SD-5323	1/4	Hex	M	6	M	Torx	1/4	30	1		EM FS RT
SD-5346-O	1/4	Hex	M	2 31/32	M	Torx	1/4	40	1		RE FS RT

Covered Nutsetter Complete Assemblies (Includes Tool and Anti-Mar Cover)

Complete Assembly Ordering Number	Nutsetter						Cover Features*
	Drive Size	Drive Type	Opening Size	Opening Type	Length (in.)	Features*	
MNC6N-08-10M-4	1/4	Hex	8 mm	Hex	4	M	FS FT
MNC6N-08-10M-6	1/4	Hex	8 mm	Hex	6	M	FS FT
SMNC6B-08-10M-4	1/4	Hex	8 mm	Hex	4	SM	FS FT
SMNC6B-08-10M-6	1/4	Hex	8 mm	Hex	6	SM	FS FT
SMNC6B-08-10M-9	1/4	Hex	8 mm	Hex	9	SM	FS FT
VMNC-56-10MM	1/4	Hex	10 mm	Hex	2.54		RT PF

Covered Socket Complete Assemblies (Includes Tool and Anti-Mar Cover)

Complete Assembly Ordering Number	Socket						Cover Features*
	Drive Size	Drive Type	Opening Size**	Opening Type	Length (in.)	Features*	
MRNC-5.5MME1	1/4	Square	5.5	Hex	0.938	M R	FT PF
MRNC-7MME1	1/4	Square	7	Hex	0.875	M R	FT PF
RMBNC-7MM21	1/4	Square	7	Hex	1.75	R B	FT PF
RMBNC-10MM21	1/4	Square	10	Hex	1.75	R B	FT PF
MNC-10MM11	1/4	Square	10	Hex	1	M	FT PF
VANC-229-10MM	1/4	Square	10	Hex	1.75	M B	FT PF
MRHCNC-22612	3/8	Square	3/8	Hex	1.25	M R TD	RT PF PC
HCNC-22512	3/8	Square	3/8	Hex	1.5	TD SB	FT PF PC
HCNC-13014	3/8	Square	7/16	Hex	1.5	TD SB	FT PF PC
HCNC-13414	3/8	Square	7/16	Hex	1.5	TD	FT PF PC
HCNC-20918	3/8	Square	9/16	Hex	3.5		FT PF PC
BZCNC-30	3/8	Square	3/4	Bezel	1.5	4 lugs	ET PF PC
HCNC-2424	3/8	Square	3/4	Dbl. Hex	0.89	stepped	FT PF PC
BZCNC-31	3/8	Square	69/94	Bezel	1.5	4 lugs	ET PF PC
HCNC-1130-D	3/8	Square	15/16	Dbl. Hex	1.25	stepped	FT PF PC
MVCNC-53-7MM	3/8	Square	7	Hex	2	M	FT PF

Continued on next page.

**Fractions represent inches. Integers represent metric (mm).

*Features Abbreviations	ER Embedded Rare Earth Magnets	LC Limited Clearance	R Rare Earth Magnet	SF Surface Drive
B Bolt Clearance	ET Exposed Tip	M Magnetic	RE Retractable / Finder Sleeve	SM Strip Magnet
DM Donut Magnet	FL Fast Lead	P Pinned	RNT Removable Nylon Tip	TD Turned OD
EC Extension Cover Only	FS Free Spinning	PC Partially Covered	RT Recessed Tip	U Universal (Swivel)
EM Embedded Magnets	FT Flush to Tip	PF Press Fit	SB Shallow Broach	

Covered Socket with Extension Complete Assemblies (Includes Tool and Anti-Mar Cover)

Complete Assembly Ordering Number	Extension				Socket				Cover Features*
	Drive Size	Drive Type	Sex	Length (in.)	Opening Size	Opening Type	Length (in.)	Features*	
MNC-8MM23	3/8	Square	8	Hex	2	M	RT PF PC		
MBVCNC-707-10MM	3/8	Square	10	Hex	2	M B	RT PF PC		
MBVCNC-731-10MM	3/8	Square	10	Hex	2	M B TD	FT PF PC		
MBVCNC-733-10MM	3/8	Square	10	Hex	2	M B TD	RT PF PC		
MBVCNC-781-10MM	3/8	Square	10	Hex	2	M B TD	FT PF PC		
MBVCNC-795-10MM	3/8	Square	10	Hex	2	M B	RT PF PC		
MVCNC-734-10MM	3/8	Square	10	Hex	2	M	FT PF		
RMBNC-10MM23	3/8	Square	10	Hex	2	R B	FT PF		
VCNC-736-10MM	3/8	Square	10	Hex	1.25		RT PF		
VCNC-790-10MM	3/8	Square	10	Hex	1.25	TD	RT PF PC		
VCSFNC-789-10MM	3/8	Square	10	Hex	3.5	SF TD	FT PF		
VCNC-791-10MM-D	3/8	Square	10	Hex	1.25		RT PF PC		
VCNC-792-10MM-D	3/8	Square	10	Hex	2		RT PF PC		
MVC-610-13MM	3/8	Square	13	Hex	1.5	M SF	RT PF PC		
VCNC-631-13MM	3/8	Square	13	Hex	1.5		RT PF		
MBVCNC-634-13MM	3/8	Square	13	Hex	2	M B	RT PF PC		
VCNC-667-13MM	3/8	Square	13	Hex	3.5		RT PF PC		
VCSFNC-633-13MM	3/8	Square	13	Hex	2.6	SF	RT PF PC		
VCNC-69-24MM	3/8	Square	24	Hex	1.5		RT PF PC		
MBVENC-104-13MM	1/2	Square	13	Hex	2.25	M B	FT PF		
MNC-17MM55	1/2	Square	17	Hex	3.25	M	FT PF		
SMVENC-105-18MM	1/2	Square	18	Hex	1.5	SM	FT PF		
VESFNC-153-19MM	1/2	Square	19	Hex	3.25	SF	FT PF		
VESFNC-105-21MM	1/2	Square	21	Hex	1.5	SF	FT PF		
HFSF-14424	5/8	Square	3/4	Hex	1.914	SF	RT PF PC		
VFSFNC-118-19MM	5/8	Square	19	Hex	1.875	SF TD	RT PF PC		
MBVFNC-117-19MM	5/8	Square	19	Hex	3.5	M B SF TD	RT PF PC		
VFSFNC-103-19MM	5/8	Square	19	Hex	3.5	SF TD	RT PF PC		
VFSFNC-110-19MM	5/8	Square	19	Hex	3.5	SF TD	RT PF PC		
VFSFNC-111-19MM	5/8	Square	19	Hex	3.5	SF TD	RT PF PC		
VFSFNC-112-19MM	5/8	Square	19	Hex	3.5	SF TD	RT PF PC		
MVFNC-99-19MM	5/8	Square	19	Hex	3.545		RT PF PC ER		
MRVFSFNC-115-19MM	5/8	Square	19	Hex	3.75	M R SF TD	RT PF PC		
MBRVFNC-116-19MM	5/8	Square	19	Hex	4.5	M B R	RT PF PC		
MBRVFSFNC-119-19MM	5/8	Square	19	Hex	4.5	M B R SF	RT PF PC		
RMBRVFNC-114-19MM	5/8	Square	19	Hex	4.5	M R	RT PF PC		
MRMBVFSFNC-20-21MM	5/8	Square	21	Hex	3	M R SF	RT PF PC		
MRVFSFNC-18-21MM	5/8	Square	21	Hex	3	M R SF	RT PF PC		
RMBVFSFNC-18-21MM	5/8	Square	21	Hex	3	M B R SF	RT PF PC		
HGSF-13824-A	3/4	Square	3/4	Hex	3.125	SF	RT PF PC		
HGSFNC-14524	3/4	Square	3/4	Hex	4	SF	RT PF PC		
MHGNC-14624	3/4	Square	3/4	Hex	4	M TD	RT PF PC		
HGSFNC-3028	3/4	Square	7/8	Hex	4	SF	RT PF PC		
VGNC-105-17MM	3/4	Square	17	Hex	2.375	TD	RT PF PC		
VGNC-108-17MM	3/4	Square	17	Hex	3.25	TD	RT PF PC		
VGSFNC-109-17MM	3/4	Square	17	Hex	4	SF TD	RT PF PC		
VGNC-28-19MM	3/4	Square	19	Hex	2.375	TD	RT PF PC		
VGSFNC-34-19MM	3/4	Square	19	Hex	3.25	SF TD	RT PF PC		
VGSFNC-56-21MM	3/4	Square	21	Hex	4	SF TD	RT PF PC		
RMBVGSFNC-53-21MM	3/4	Square	21	Hex	4.5	M B R SF	RT PF PC		
VGSFNC-55-21MM	3/4	Square	21	Hex	6	SF	RT PF		
VGFLNC-40-22MM	3/4	Square	22	Hex	2.5	FL	RT PF PC		
VGSFNC-40-22MM	3/4	Square	22	Hex	2.5	SF	RT PF PC		
MBRVGNC-34-22MM	3/4	Square	22	Hex	4	M B R	RT PF PC		
MRBRVGSFNC-38-22MM	3/4	Square	22	Hex	4	M B R SF	RT PF PC		
VGSFNC-39-22MM	3/4	Square	22	Hex	4	SF TD	RT PF PC		

*Features Abbreviations	ER Embedded Rare Earth Magnets	LC Limited Clearance	R Rare Earth Magnet	SF Surface Drive
B Bolt Clearance	ET Exposed Tip	M Magnetic	RE Retractable / Finder Sleeve	SM Strip Magnet
DM Donut Magnet	FL Fast Lead	P Pinned	RNT Removable Nylon Tip	TD Turned OD
EC Extension Cover Only	FS Free Spinning	PC Partially Covered	RT Recessed Tip	U Universal (Swivel)
EM Embedded Magnets	FT Flush to Tip	PF Press Fit	SB Shallow Broach	

Covered Socket Complete Assemblies – continued (Includes Tool and Anti-Mar Cover)

Complete Assembly Ordering Number	Socket						Cover Features*
	Drive Size	Drive Type	Opening Size**	Opening Type	Length (in.)	Features*	
MBVANC-85-8MM	1/4	Square	F	3	8	Hex	1.75 M B FS
MVMNC-8-7MM	1/4	Hex	M	6	7	Hex	0.875 M FS
MRVMNC-9-7MM	1/4	Hex	M	8	7	Hex	0.875 R FS
MVMNC-9-7MM	1/4	Hex	M	8	7	Hex	0.875 M FS
MVMNC-61-10MM	1/4	Hex	M	1.625	10	Hex	1.25 M FS
MRSFVMNC-58-10MM	1/4	Hex	M	3	10	Hex	1.75 R SF FS
MVMSFNC-62-10MM	1/4	Hex	M	4	10	Hex	1.75 M SF FS
MBVMNC-63-10MM	1/4	Hex	M	6	10	Hex	1.75 M B FS
MBVMNC-65-10MM	1/4	Hex	M	6	10	Hex	2 M B FS
MVMNC-60-10MM	1/4	Hex	M	6	10	Hex	1 M FS
MVMSFNC-60-10MM	1/4	Hex	M	6	10	Hex	1 M SF FS
SMVMNC-65-10MM	1/4	Hex	M	6	10	Hex	2 SM FS
VMNC-70-10MM	1/4	Hex	M	6	10	Hex	1.75 M B FS
MBVMNC-64-10MM	1/4	Hex	M	8	10	Hex	1.75 M B FS
VMNC-6-13MM	1/4	Hex	M	1.625	13	Hex	2 M B FS
MBVMNC-5-13MM	1/4	Hex	M	2	13	Hex	3.5 M B FS
MVMNC-1-15MM	1/4	Hex	M	1.625	15	Hex	2 M FS
VMNC-2-15MM	1/4	Hex	M	1.625	15	Hex	2 M FS
VMNC-1-16MM	1/4	Hex	M	1.625	16	Hex	2 M FS
VMNC-2-19MM	1/4	Hex	M	1.625	19	Hex	2 M FS
VMNC-1-21MM	1/4	Hex	M	2	21	Hex	1.5 M FS
VCNC-248-8MM	3/8	Square	F	3	8	Hex	1.25 M FS
MVCNC-752-10MM	3/8	Square	F	2	10	Hex	1.25 M FS
MBVCNC-754-10MM	3/8	Square	F	3	10	Hex	2 M B FS
MRSFVCNC741-10MM-NU	3/8	Square	F	3	10	Hex	1.75 R SF FS
MRVCSFNC-724-10MM	3/8	Square	F	3	10	Hex	2 R SF FS
MVCNC-710-10MM	3/8	Square	F	3	10	Hex	1.25 M FS
MVCNC-750-10MM	3/8	Square	F	3	10	Hex	1.25 M FS
VCNC-751-10MM	3/8	Square	F	3	10	Hex	1.25 M FS
MBVCNC-747-10MM	3/8	Square	F	4	10	Hex	3.5 M B FS
MBVCNC-762-10MM	3/8	Square	F	4	10	Hex	2 M B FS
MVCNC-748-10MM	3/8	Square	F	4	10	Hex	1.25 M FS
MVCNC-755-10MM	3/8	Square	F	4	10	Hex	1.25 M FS
VCNC-758-10MM	3/8	Square	F	4	10	Hex	0.875 M FS
RMBVCNC-728-10MM	3/8	Square	F	5	10	Hex	2 R B FS
MVCNC-702-10MM	3/8	Square	F	6	10	Hex	1.25 M FS
MVCNC-702-10MM-NA	3/8	Square	F	6	10	Hex	1.25 M FS
MVCNC-702-10MM-NU	3/8	Square	F	6	10	Hex	1.25 M FS
MVCNC-746-10MM	3/8	Square	F	6	10	Hex	1.25 M FS
SMVCNC-764-10MM	3/8	Square	F	6	10	Hex	2 SM FS
MBVCNC-745-10MM	3/8	Square	F	8	10	Hex	3.5 M B FS
MVCNC-756-10MM	3/8	Square	F	8	10	Hex	1.25 M FS
MVCNC-759-10MM	3/8	Square	F	10	10	Hex	0.875 M FS
RMBVCNC-727-10MM	3/8	Square	F	10	10	Hex	2 R B FS
MBVCNC-749-10MM	3/8	Square	F	12	10	Hex	3.5 M B FS
MVCNC-766-10MM	3/8	Square	F	12	10	Hex	2 M FS
SMVCNC-765-10MM	3/8	Square	F	12	10	Hex	2 SM FS
VCNC-757-10MM	3/8	Square	F	12	10	Hex	1.25 M FS
MBSFVCNC-653-13MM	3/8	Square	F	12	13	Hex	2 M B SF FS
MBVCNC-647-13MM	3/8	Square	F	2	13	Hex	3.5 M B FS
MBVCNC-645-13MM	3/8	Square	F	3	13	Hex	3.5 M B FS
MVCNC-648-13MM	3/8	Square	F	3	13	Hex	1.5 M FS
SMVCSFNCNU-624-13M	3/8	Square	F	3	13	Hex	1.5 RE SM SF FS
MBVCNC-651-13MM	3/8	Square	F	4	13	Hex	2 M B FS
MBVCNC-644-13MM	3/8	Square	F	6	13	Hex	3.5 M B FS
MRVCNC-628-13MM-NU	3/8	Square	F	6	13	Hex	1.5 R FS
MRVCNC-662-13MM-NA	3/8	Square	F	6	13	Hex	1.5 R FS
MSFVCNC-652-13MM	3/8	Square	F	6	13	Hex	2 M SF FS

*Features Abbreviations	ER Embedded Rare Earth Magnets	LC Limited Clearance	R Rare Earth Magnet	SF Surface Drive
B Bolt Clearance	ET Exposed Tip	M Magnetic	RE Retractable / Finder Sleeve	SM Strip Magnet
DM Donut Magnet	FL Fast Lead	P Pinned	RNT Removable Nylon Tip	TD Turned OD
EC Extension Cover Only	FS Free Spinning	PC Partially Covered	RT Recessed Tip	U Universal (Swivel)
EM Embedded Magnets	FT Flush to Tip	PF Press Fit	SB Shallow Broach	



Solutions

Covered Socket with Extension Complete Assemblies – continued *(Includes Tool and Anti-Mar Cover)*

Complete Assembly Ordering Number	Extension				Socket				Cover Features*
	Drive Size	Drive Type	Sex	Length (in.)	Opening Size	Opening Type	Length (in.)	Features*	
MVCNC-649-13MM	3/8	Square	F	6	13	Hex	2	M	FS
MVCNCNU-625-13MM	3/8	Square	F	6	13	Hex	1.5	M	FS
MBVCNC-652-13MM	3/8	Square	F	8	13	Hex	2	M B	FS
SMSFVCNC637-13M-NU	3/8	Square	F	8	13	Hex	2	SM SF	FS
MBVCNC-654-13MM	3/8	Square	F	10	13	Hex	2	M B	FS
MVCNC-646-13MM	3/8	Square	F	10	13	Hex	1.5	M	FS
MBVCNC-653-13MM	3/8	Square	F	12	13	Hex	2	M B	FS
MVCNC-650-13MM	3/8	Square	F	12	13	Hex	1.5	M	FS
VCNC-653-13MM	3/8	Square	F	12	13	Hex	2		FS
VCNC-239-14MM	3/8	Square	F	10	14	Hex	2		FS
MBVCNC-135-15MM	3/8	Square	F	6	15	Hex	2	M B	FS
VCSFNC-132-15MM-NA	3/8	Square	F	12	15	Hex	1.5	SF	FS
DMVCSFNC-623-13MM	7/16	Square	F	3	13	Hex	1	DM SF	RE
MBVNNC-1-13MM	7/16	Hex	M	8	13	Hex	2	M B	FS
MRVNNC-1-15MM	7/16	Hex	M	6	15	Hex	3.25	R	FS
MVENC-1-7MM	1/2	Square	F	1.5	7	Hex	1.25	M	FS
MVENC-143-10MM	1/2	Square	F	1.5	10	Hex	1.25	M	FS
MBRVENC-108-18MM	1/2	Square	F	8	18	Hex	2.25	R B	FS
MRVENC-101-18MM	1/2	Square	F	20	18	Hex	1.5	R SF	FS

Covered Socket with Extension & Adapter Complete Assemblies *(Includes Tool and Anti-Mar Cover)*

Complete Assembly Ordering Number	Adapter				Extension				Socket			Adapter Features*	Socket Features*	Cover Features*
	Drive Size	Drive Type	Sex	Length (in.)	Drive Size	Drive Type	Sex	Length (in.)	Opening Size**	Opening Type	Length (in.)			
MRVANC-97-7MM	1/4	Square	F	1.5	1/4	Hex	M	6	7	Hex	0.875	QR	R	FS
MVCNC-760-10MM	3/8	Square	F	1.75	1/4	Hex	M	6	10	Hex	1	QR	M	FS
MBVCNC-763-10MM	3/8	Square	F	2	7/16	Hex	M	8	10	Hex	2	QR	B, M	FS
MVCNC-761-10MM	3/8	Square	F	2	7/16	Hex	M	8	10	Hex	1.25	QR	M	FS
VCNC-761-10MM	3/8	Square	F	2	7/16	Hex	M	8	10	Hex	1.25	QR		FS
RCSFNC-1314-9	3/8	Square	F	1.5	1/4	Hex	M	9	7/16	Hex	1.062	P	U, SF	EC, FS
RMSFNC-214-9	-	-	-	-	1/4	Hex	M	9	7/16	Hex	1.062	P	U, SF	EC, FS
RCNC-2616-9	3/8	Square	F	1.5	1/4	Hex	M	9	1/2	Hex	1	P	U	EC, FS
RCSFNC-2816-9	3/8	Square	F	1.5	1/4	Hex	M	9	1/2	Hex	1.062	P	U, SF	EC, FS

**Fractions represent inches. Integers represent metric (mm).

If you have an assembly application that requires special protection, simply fill out the appropriate attached "Quotation Worksheet" and fax it to your Apex Representative. Indicate that a nylon coating is needed. Or, you can visit our website at www.apex-tools.com and submit a "Quotation Worksheet" electronically. Either way, a quote will be generated promptly.

If you need more information or would like to have an Apex Representative contact you, please call Customer Service toll free at 1-800-845-5629.

Does Apex offer sockets for the installation of grease fittings?

Specially designed Apex sockets are the easy way to install or remove grease fittings.

(See page 83)



What's the real advantage of using socket adapters?

Socket adapters are an easy and economical solution for applications that require several different nut sizes.

(See page 85)



Does Apex offer tap holding sockets?

Apex offers a wide variety of tap holding adapters. These adapters allow you to easily convert your power tool into a tap drill.

(See page 83)

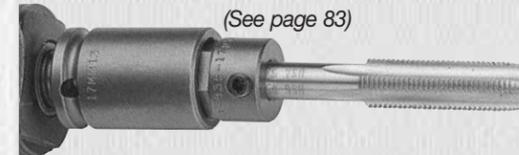

What's the advantage of a male hex drive socket?

A male hex drive socket lets you quickly accommodate a different nut size without pulling the primary socket off the power tool.

(See page 85)



Reversible Sockets for SAE Hex Head Sheet Metal Screws



Standard

Part Number	Hex Size	Overall Length	Outside Diameter	Roll Pin Part Number
SW-350	1/4	9/16	3/8	21-S-078-0375
SH-402	13/16	3/4	13/16	21-S-078-0750

Magnetic

Part Number	Hex Size	Overall Length	Outside Diameter	Spring Pin Part Number
MSW-350	1/4	31/32	3/8	21-S-078-0375
MSW-90	1/4	31/32	7/16	21-S-078-0437
MSW-90-B*	1/4	31/32	7/16	21-S-078-0437
MSW-984	5/16	31/32	9/16	21-S-078-0562
MSW-984-B*	5/16	31/32	9/16	21-S-078-0562
MSH-400	3/8	1 1/8	11/16	21-S-078-0687

*Tapered Ends

Shanks for Reversible Sockets



Part Number	Male Hex Power Drive	Male Hex Size	Overall Length	
SH-629	1/4	1/4	2	
SH-629-P	1/4	1/4	2	Pin Lock
SH-629-5	1/4	1/4	5	
SH-629-6	1/4	1/4	6	
SH-57	1/4	1/4	2	Full Length Hex
SH-57-3	1/4	1/4	3	Full Length Hex
SH-57-4	1/4	1/4	4	Full Length Hex
SH-57-6	1/4	1/4	6	Full Length Hex
SH-57-8	1/4	1/4	8	Full Length Hex
SH-59	1/4	5/16	2	
SH-59-3	1/4	5/16	3	
SH-59-4	1/4	5/16	4	
SH-59-6	1/4	5/16	6	
SH-412	1/4	3/8	2	
SH-414	1/4	1/2	2	
SH-404	7/16	3/8	2	

BOLDED part numbers are industry popular items and are followed by common variations which may vary in price and availability.

Tap Holding Sockets

Male Hex Drive, SAE



Part Number	Tap Size	Male Hex	Socket Length		Socket Diameter	
			In.	mm	In.	mm
SJ-935-1/4	1/4	7/16	15/16	24	5/8	16
SJ-935-5/16	5/16	1/2	15/16	24	5/8	16
SJ-935-3/8FS	3/8	9/16	1	25	21/32	17
SJ-935-7/16	7/16	5/8	1	25	3/4	19
SJ-935-1/2	1/2	3/4	1 1/4	32	7/8	22

Male Hex Drive, Metric



Part Number	Tap Size	Male Hex	Socket Length		Socket Diameter	
			In.	mm	In.	mm
SJ-935-10XM6	M6	10	15/16	24	5/8	16
SJ-935-12XM8	M8	12	15/16	24	5/8	16
SJ-935-14XM10	M10	14	1	25	21/32	17
SJ-935-17XM8	M8	17	1	25	13/16	21
SJ-935-17XM12	M12	17	1	25	13/16	21

Female Sq. Dr., SAE



Part Number	Tap Size	Female Square	Socket Length		Socket Diameter	
			In.	mm	In.	mm
HC-100-10	#10	3/8	1 1/2	38	3/4	19
HC-100-1/4	1/4	3/8	1 1/2	38	3/4	19
HC-100-5/16	5/16	3/8	1 1/2	38	3/4	19
HC-100-3/8FS	3/8	3/8	1 1/2	38	3/4	19
HC-100-7/16	7/16	3/8	1 1/2	38	3/4	19
HC-100-1/2	1/2	3/8	1 1/2	38	3/4	19
HC-100-5/8	5/8	3/8	1 3/4	46	1	25
HC-100-3/4	3/4	3/8	2	51	1	25
HE-100-1/4	1/4	1/2	1 1/2	38	7/8	22
HE-100-5/16	5/16	1/2	1 1/2	38	7/8	22
HE-100-3/8FS	3/8	1/2	1 1/2	38	7/8	22
HE-100-7/16	7/16	1/2	1 1/2	38	7/8	22
HE-100-1/2	1/2	1/2	1 5/8	41	7/8	22
HE-100-5/8	5/8	1/2	1 3/4	46	1	25
HE-100-3/4	3/4	1/2	2	51	1	25

Grease Fitting Sockets

For Angled Grease Fittings, Deep and Shallow Broach Depth



Part Number	6 Point	Magnetic	Hex Size	Square Drive	Overall Length		Broach Depth		Magnet Depth	
					In.	mm	In.	mm	In.	mm
ZN-112	-	-	3/8	1/4	1 1/4	32	9/16	14	-	-
ZN-312	MZN-312	-	3/8	3/8	1 1/2	38	9/16	14	7/32	6
ZN-512	-	-	3/8	1/2	1 1/2	32	9/16	14	-	-
ZN-114	-	-	7/16	1/4	1 1/4	32	7/16	11	-	-
ZN-314	MZN-314	-	7/16	3/8	1 1/2	38	7/16	11	7/16	11
ZN-514	MZN-514	-	7/16	1/2	1 1/2	38	7/16	11	7/16	11
ZE-112	-	-	3/8	1/4	1 1/4	32	1/8	3	-	-
ZE-314	-	-	7/16	3/8	1 1/2	38	3/16	5	-	-
ZE-514	-	-	7/16	1/2	1 1/2	38	3/16	5	-	-

For Straight Grease Fittings



Part Number	6 Point	Magnetic	Hex Size	Square Drive	Overall Length		Broach Depth		Magnet Depth	
					In.	mm	In.	mm	In.	mm
ZA-110	MZA-110	-	5/16	1/4	1	25	1/8	3	21/64	8
ZA-310	MZA-310	-	5/16	3/8	1 1/4	32	1/8	3	21/64	8
ZA-510	MZA-510	-	5/16	1/2	1 1/2	38	1/8	3	19/64	7
ZA-512	-	-	3/8	1/2	1 1/2	38	1/8	3	-	-
ZA-314	MZA-314	-	7/16	3/8	1 1/4	32	3/16	5	23/64	9
ZA-514	MZA-514	-	7/16	1/2	1 1/2	38	3/16	5	3/8	10

Drill Holders

1/4" Male Hex Drive



Part Number	Drill Size	Overall Length	Body Diameter
		In.	mm
WJ-284-7/64	7/64	2 5/8	67
WJ-284-1/8	1/8	2 5/8	67
WJ-284-9/64	9/64	2 5/8	67
WJ-284-5/32	5/32	2 5/8	67
WJ-284-3/16	3/16	2 5/8	67
WJ-284-1/4	1/4	2 5/8	67
WJ-284-5/16	5/16	2 5/8	67
WJ-284-3/8	3/8	2 5/8	67

7/16" Male Hex Drive



Part Number	Drill Size	Overall Length	Body Diameter
		In.	mm
WJ-265-13/64	13/64	2 3/8	60
WJ-265-3/16	3/16	2 3/8	60
WJ-265-1/4	1/4	2 3/8	60
WJ-265-7/16	7/16	2 3/8	60
WJ-265-3/8	3/8	2 3/8	60
WJ-265-17/32	17/32	2 3/8	60
WJ-265-1/2	1/2	2 3/8	60

BOLDED part numbers are industry popular items and are followed by common variations which may vary in price and availability.

#5 (1 5/8") Spline Drive



Extensions

Part Number	Overall Length		Female spline to male spline
	In.	mm	
EXL-15	15	381	

Adapters



Part Number	Female spline to 1" male square
EXL-1000	Female spline to 1" male square
EXL-1100	Female spline to 1 1/2" male square

Universal Wrenches



Part Number	Female spline to male spline (heavy duty)
MFL-250	Female spline to male spline (heavy duty)
MFL-1000	Female spline to 1" male square

Universal wrenches must not be used with impact drivers. Maximum operating angle is 30°.

#5 (1 5/8") Spline Drive Budd Wheel Sockets



Combo. 13/16" Square 1 1/2" Hex

Part Number	Drive	Overall Length	
		In.	mm
HT-848	#5 Spline	4 1/4	108

Socket Retaining Rings

Plastic Ring With Steel Insert



Part Number	Drive	Inside Diameter In.	Inside Diameter mm
10005S	3/4" Square	1 1/4	31.8
10032S	3/4" Square	1 7/16	36.5
10034S	3/4" Square	1 5/8	41.3
10008S	1" Square	1 3/4	44.5
10010S	1" Square	2	50.8
10015S	1" Square	2 1/8	54.0
10016S	1" Square	2 1/4	57.2
10017S	1" Square	2 1/2	63.5
10019S	1" Square	2 5/8	66.7
10020S	1 1/2" Square	2 7/8	73.0
10025S	1 1/2" Square	3 3/8	85.7

Metal Ring



Part Number	Drive	Inside Diameter In.	Inside Diameter mm
MET-1301C	3/8" Square	.677	17.2
MET-1302C	3/8" Square	.771	19.6
MET-1401C	1/2" Square	.885	22.5
MET-1402C	1/2" Square	1.086	27.6
MET-1600C	3/4" Square	1.594	40.5
MET-1800C	1" Square	1.948	49.5

Adapters

#130-A Yankee Drive for Spiral Type Driver



Part Number	Male Square In.	Overall Length In.	Overall Length mm	Shank Diameter In.	Shank Diameter mm
YK-250	1/4	1 15/16	49	.277	7.0
YK-370	3/8	2 3/16	56	.277	7.0
YK-500	1/2	2 5/16	59	.277	7.0

#131-A Yankee Drive for Spiral Type Driver



Part Number	Male Square In.	Overall Length In.	Overall Length mm	Shank Diameter In.	Shank Diameter mm
YK-501	1/2	2 5/16	59	.310	8.0

#135-A Yankee Drive for Spiral Type Driver



Part Number	Male Square In.	Overall Length In.	Overall Length mm	Shank Diameter In.	Shank Diameter mm
YK-250	1/4	1 15/16	49	.215	5.5
YK-370	3/8	2 3/16	56	.215	5.5
YK-500	1/2	2 5/16	59	.215	5.5

Female Threaded Adapters



Part Number	Female Thread	Male Square In.	Type of Lock
TH-257	3/8"-24	1/4	Pin
TH-377	3/8"-24	3/8	Pin
TH-501	3/8"-24	1/2	Pin
TH-378	1/2"-20	3/8	Pin
TH-502	1/2"-20	1/2	Pin

Male Threaded Adapters



Part Number	Male Thread	Hex Drive
TM-24	3/8"-24	1/4
TN-24	3/8"-24	7/16
TM-20	1/2"-20	1/4
TN-20	1/2"-20	7/16

Adapters

Socket & Ratchet Wrench Adapters, SAE



Part Number	Male Square In.	Male Hex In.	Overall Length In.
A-108	1/4	1/4	25/32
A-110	1/4	5/16	25/32
A-112	1/4	3/8	25/32
A-114	1/4	7/16	25/32
A-116	1/4	1/2	25/32
A-118	1/4	9/16	25/32
A-120	1/4	5/8	25/32
A-312	3/8	3/8	1 1/64
A-314	3/8	7/16	1 1/64
A-316	3/8	1/2	1 5/64
A-318	3/8	9/16	1 5/64
A-320	3/8	5/8	1 5/64
A-322	3/8	11/16	1 5/64
A-324	3/8	3/4	1 5/64
A-328	3/8	7/8	1 5/64
A-512	1/2	3/8	1 3/32
A-514	1/2	7/16	1 3/32
A-516	1/2	1/2	1 3/32
A-518	1/2	9/16	1 3/32
A-520	1/2	5/8	1 1/8
A-522	1/2	11/16	1 1/8
A-524	1/2	3/4	1 1/8
A-526	1/2	13/16	1 1/8
A-528	1/2	7/8	1 1/8
A-530	1/2	15/16	1 1/8
A-534	1/2	1 1/16	1 1/8
A-536	1/2	1 1/8	1 1/8
A-538	1/2	1 3/16	1 1/8
A-540	1/2	1 1/4	1 1/8

Sockets with Male Hex



Part Number	Female Square In.	Male Hex In.	Overall Length In.	Overall Length mm
SJ-375	5/16	3/8	13/16	21
SJ-379	1/2	3/8	1	25
SJ-380	9/16	3/8	1	25
SJ-349	3/8	7/16	15/16	24
SJ-350	7/16	7/16	15/16	24
SJ-351	1/2	7/16	1	25
SJ-352	9/16	7/16	1	25
SJ-360	3/8	1/2	15/16	24
SJ-361	7/16	1/2	15/16	24
SJ-241	1/2	1/2	1	25
SJ-362	9/16	1/2	1	25
SJ-364	11/16	1/2	1 3/16	30
SJ-55	7/16	9/16	15/16	24
SJ-66	1/2	9/16	1	25
SJ-67	9/16	9/16	1	25
SJ-68	5/8	9/16	1 1/8	28

Socket & Ratchet Wrench Adapters, Metric



Part Number	Male Square In.	Male Hex mm	Overall Length In.	Overall Length mm
A-1-6mm	1/4	6	25/32	20
A-1-7mm	1/4	7	25/32	20
A-1-8mm	1/4	8	25/32	20
A-1-9mm	1/4	9	25/32	20
A-1-10mm	1/4	10	25/32	20
A-1-11mm	1/4	11	25/32	20
A-1-12mm	1/4	12	25/32	20
A-1-13mm	1/4	13	25/32	20
A-3-10mm	3/8	10	15/16	24
A-3-11mm	3/8	11	15/16	24
A-3-12mm	3/8	12	15/16	24
A-3-13mm	3/8	13	15/16	24
A-3-14mm	3/8	14	15/16	24
A-3-15mm	3/8	15	15/16	24
A-3-16mm	3/8	16	15/16	24
A-3-17mm	3/8	17	15/16	24
A-3-18mm	3/8	18	15/16	24
A-3-19mm	3/8	19	15/16	24
A-5-10mm	1/2	10	1 1/8	29
A-5-11mm	1/2	11	1 1/8	29
A-5-12mm	1/2	12	1 1/8	29
A-5-13mm	1/2	13	1 1/8	29
A-5-14mm	1/2	14	1 1/8	29
A-5-15mm	1/2	15	1 1/8	29
A-5-16mm	1/2	16	1 1/8	29
A-5-17mm	1/2	17	1 1/8	29
A-5-18mm	1/2	18	1 1/8	29
A-5-19mm	1/2	19	1 1/8	29
A-5-20mm	1/2	20	1 1/8	29
A-5-21mm	1/2	21	1 1/8	29
A-5-22mm	1/2	22	1 1/8	29
A-5-23mm	1/2	23	1 1/8	29
A-5-24mm	1/2	24	1 1/8	29
A-5-25mm	1/2	25	1 1/8	29

Hex Drive Universal Adapters



Male Hex to Male Square - Extension

Part Number Standard	Tension	Male Sq. In.	Male Hex In.	Type of Lock	Overall Length In.	Overall Length mm	Largest Diameter In.	Largest Diameter mm
-	KSM-25-3	1/4	1/4	Pin	3	76	5/8	15.9
KCM-25-B-6	KSM-25-B-6	1/4	1/4	Ball	6	152	5/8	15.9
KCM-37-6	KSM-37-6	3/8	1/4	Pin	6	152	3/4	19.1
-	KSM-37-B-6	3/8	1/4	Ball	6	152	3/4	19.1

Universal wrenches must not be used with impact drivers. Maximum operating angle is 30°. Standard lengths are 3", 6", 9" and 12" (76, 152, 229 and 305mm).

BOLDED part numbers are industry popular items and are followed by common variations which may vary in price and availability.

BOLDED part numbers are industry popular items and are followed by common variations which may vary in price and availability.

Screwdriver Bit Quotation Worksheet

For quotation only. Not an order.

NAME		TITLE	
COMPANY			
ADDRESS	CITY	STATE	ZIP
E-MAIL	PHONE	FAX	

<input type="checkbox"/> Phillips	<input type="checkbox"/> Torx®	<input type="checkbox"/> Frearson/Reed Prince	<input type="checkbox"/> Torx-Set®
<input type="checkbox"/> Phillips ACR®	<input type="checkbox"/> Torx Plus®	<input type="checkbox"/> Socket Head	<input type="checkbox"/> Triple Square
<input type="checkbox"/> Slotted	<input type="checkbox"/> Pozidriv®	<input type="checkbox"/> Socket/Robertson	<input type="checkbox"/> Tri-Wing
			<input type="checkbox"/> Other _____

Drive Type

Hex Insert  _____

Hex Power  _____

Threaded  _____

Female Square  _____

Other _____

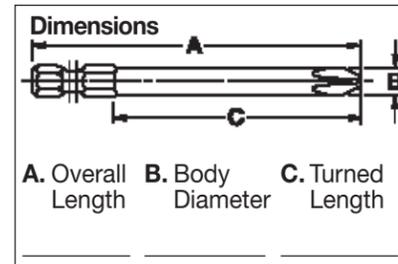

Bit Holder Styles For Hex Insert Bits

Magnetic

O-Ring Retention

Standard (Retaining Groove)

Quick Release

Other _____

Bit Holder Drive Types

Hex Drive _____

Female Square _____

Other _____

Additional Specifications _____

Quantity _____

Applied or Driving Torque _____

Sockets Quotation Worksheet

For quotation only. Not an order.



NAME		TITLE	
COMPANY			
ADDRESS	CITY	STATE	ZIP
E-MAIL	PHONE	FAX	

Socket Type

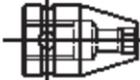
Type A (tapered) 

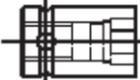
Type B (straight) 

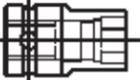
Type C (shouldered) 

Broach Opening

Hex 

Double Hex 

Square 

Double Square 

Fast Lead 

Surface Drive 

Torx® 

Other _____

Magnetic

Magnetic Bolt Clearance (MB)

Magnetic Bolt Clearance, with retaining ring (RMB)

Strip Magnet (SM)

Fixed Magnet (M)

Non-magnetic

Extensions

Hex Drive _____

Female Square _____

Other _____

Extension Length

No extension required

Drive Configuration

DIN Standard

No DIN groove

Cross Hole (one wall only)

Nylon Covers Requirements:

Components To Be Covered

Socket only

Socket and Extension

Additional Specifications _____

Quantity _____

Applied or Driving Torque _____

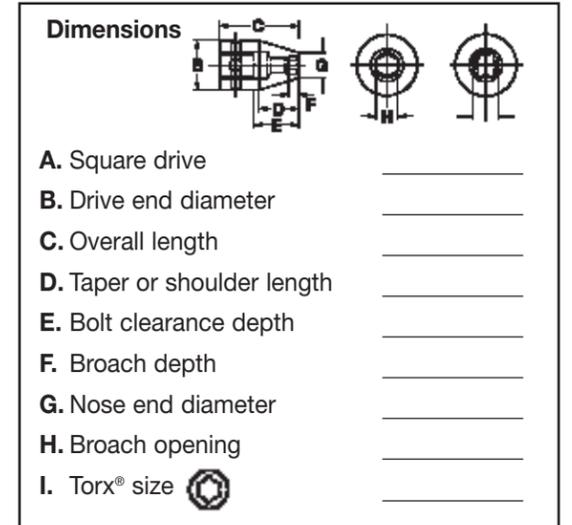

Components To Be Covered

Socket only

Socket and Extension

Cover Features

Exposed tip of socket hex

Recessed tip of socket hex

Flush tip of socket hex

Press fit

Free-spinning (able to spin independently of part being covered)

O.D. limitations (must specify) _____

Other considerations (must specify) _____

Universal Wrench Quotation Worksheet

For quotation only. Not an order.



Name _____ Title _____

Company _____

Address _____

Phone _____ FAX _____

DIMENSIONS

Female square drive, standard type

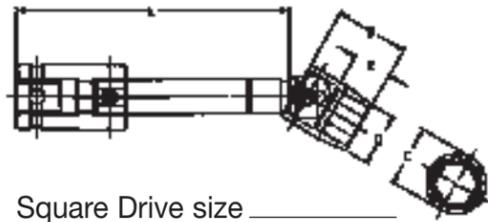

Square Drive size _____

Female square drive, tension type

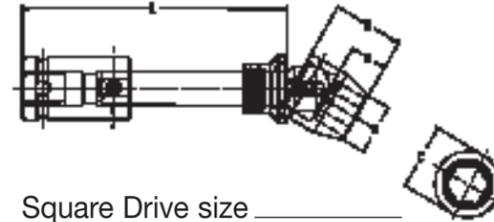

Square Drive size _____

Male hex drive, standard type

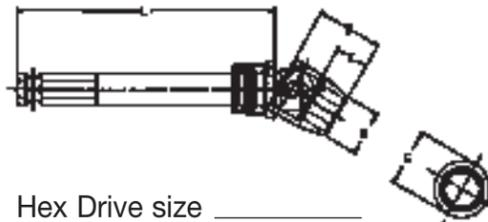

Hex Drive size _____

Male hex drive, tension type

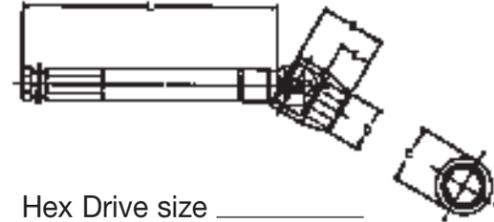

Hex Drive size _____

Female square drive, (short)

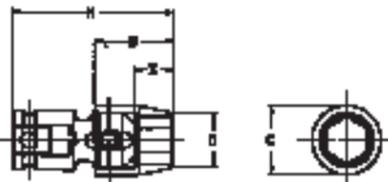

Square Drive size _____

B. Socket length _____ C. Socket diameter* _____

D. Socket nose dia. _____ G. Depth of Clearance _____

L. Shank length _____ M. Overall length _____

*Standard diameters are 5/8", 3/4", 7/8", 1", 1 1/4", 1 1/2", 1 3/4", 2"

BROACH OPENING STYLE & SIZE



Hex _____



Double Hex _____

Quantity _____



Male square _____

- Pin lock _____
- Ball lock _____
- Hole _____

APPLIED or DRIVING TORQUE _____

Additional Specifications _____

Part Number Index

Part No.	Page	Part No.	Page	Part No.	Page	Part No.	Page	Part No.	Page	Part No.	Page	Part No.	Page	Part No.	Page
01112	.67	11mm13-D	.44	13mm43-D	.44	170-3/8B	.21	1951-0X	.20	265-1	.21	3016	.40	320-20X	.7
10008S	.83	11mm15	.54	13mmE1	.79	170-3/8C	.22	1951-1X	.20	265-1/4	.22	3016-D	.40	320-2X	.7
10010S	.83	11mm15-D	.54	13mmE3	.91	170-4	.21	1951-2X	.20	265-10	.21	3018	.40	320-3X	.7
10015S	.83	11mm21	.37	14mm03	.44	170-5	.21	1951-3X	.20	265-2	.21	3018-D	.40	320-4X	.7
10016S	.83	11mm23	.44	14mm03-D	.44	170-5/16	.22	1953-1X	.20	265-3	.21	3020	.40	320-5X	.7
10017S	.83	11mm23-D	.44	14mm11	.37	170-5/16-ACR	.22	1953-2X	.20	265-4	.21	3020-D	.40	320-6X	.7
10019S	.83	11mm43	.44	14mm11-D	.37	170-5/16A	.22	1953-3X	.20	265-5	.21	3022	.40	3208	.40
10020S	.83	11mmE1	.38	14mm13	.44	170-5/16B	.21	19mm03	.44	265-5/16	.22	3022-D	.40	3208-D	.40
10025S	.83	1206	.35	14mm13-D	.44	170-5/8	.22	19mm03-D	.44	265-6	.21	3024	.40	3209	.40
10032S	.83	1206-D	.35	14mm15	.54	170-6	.21	19mm13	.44	265-8	.21	3024-D	.40	3210	.40
10034S	.83	1207	.35	14mm15-D	.54	170-6-ACR	.21	19mm13-D	.44	265A-0	.21	3028	.40	3210-D	.40
103-00X	.8	1208	.35	14mm21	.37	170-7/16	.22	19mm15	.54	265A-1	.21	3028-D	.40	3211	.40
103-1X	.8	1208-D	.35	14mm23	.44	170-7/16C	.22	19mm15-D	.54	265A-1/4	.22	309-00X	.8	3212	.40
103-2X	.8	1209	.35	14mm23-D	.44	170-8	.21	19mm23	.44	265A-10	.21	309-000X	.8	3212-D	.40
103-3X	.8	1209-D	.35	14mm43	.44	170-8-ACR	.21	19mm23-D	.44	265A-2	.21	309-1X	.8	3214	.40
103-4X	.8	1210	.35	14mm43-D	.44	170-8A	.22	19mm43	.44	265A-3	.21	309-2X	.8	3214-D	.40
103-5X	.8	1210-D	.35	1500-P	.53	170-9/16	.22	19mm43-D	.44	265A-3/8	.22	309-3X	.8	3216	.40
103-6X	.8	1211	.35	1510-P	.53	17mm03	.44	1E08	.35	265A-4	.21	309-4X	.8	3216-D	.40
10mm03	.44	1212	.35	15mm03	.44	17mm13	.44	1E10	.35	265A-5	.21	309-5X	.8	3218	.40
10mm03-D	.44	1212-D	.35	15mm03-D	.44	17mm13-D	.44	1P06	.36	265A-5/16	.22	309-6X	.8	3218-D	.40
10mm11	.37	1213	.35	15mm11	.37	17mm15	.54	1P07	.36	265A-6	.21	309-8X	.8	322-000LX	.9
10mm11-D	.37	1214	.35	15mm13	.44	17mm15-D	.54	1P08	.36	265A-7/16	.22	3108	.40	322-0LX	.9
10mm13	.44	1216	.35	15mm13-D	.44	17mm23	.44	1P10	.36	265A-8	.21	3108-D	.40	322-MX	.9
10mm13-D	.44	1216-D	.35	15mm15	.54	17mm23-D	.44	1P11	.36	26mm15	.54	3109	.40	3220	.40
10mm15	.54	1218	.35	15mm15-D	.54	17mm43	.44	1P12	.36	26mm15-D	.54	3110	.40	3220-D	.40
10mm15-D	.54	12mm03	.44	15mm21	.37	17mm43-D	.44	1P14	.36	273-0	.21	3110-D	.40	3222	.40
10mm21	.37	12mm03-D	.44	15mm21-D	.37	185-0X	.17	1P16	.36	273-1	.21	3111	.40	3222-D	.40
10mm21-D	.37	12mm11	.37	15mm23	.44	185-00X	.17	20mm03	.44	273-10	.21	3112	.40	3224	.40
10mm23	.44	12mm11-D	.37	15mm23-D	.44	185-000X	.17	20mm15	.54	273-2	.21	3112-D	.40	3224-D	.40
10mm23-D	.44	12mm13	.44	15mm33	.44	185-1.5mm	.17	212-0	.21	273-3	.21	3113	.40	3226	.40
10mm23-D	.44	12mm13-D	.44	15mm33-D	.44	185-10mm	.17	212-1	.21	273-4	.21	3113-D	.40	3226-D	.40
10mm33	.44	12mm15	.54	15mm43	.44	185-10X	.17	212-1/4	.21	273-5	.21	3114	.40	3228	.40
10mm43	.44	12mm15-D	.54	15mm43-D	.44	185-1XX	.17	212-1/4A	.21	273-6	.21	3114-D	.40	3228-D	.40
10mm43-D	.44	12mm21	.37	1608	.36	185-2.5mm	.17	212-1/4A-ACR	.21	273-8	.21	3116	.40	323-0X	.7
10mmE1	.38	12mm23	.44	1608-D	.36	185-2mm	.17	212-10	.21	273A-1	.21	3116-D	.40	323-00X	.7
10mmE3	.45	12mm23-D	.44	1612	.36	185-2X	.17	212-10A	.21	273A-10	.21	3117	.40	323-000X	.7
1105	.35	12mm43	.44	1612-D	.36	185-3mm	.17	212-2	.21	273A-2	.21	3118	.40	323-1X	.7
1106	.35	12mm43-D	.44	16mm03	.44	185-3X	.17	212-3	.21	273A-3	.21	3119	.40	323-2X	.7
1106-D	.35	12mmE1	.38	16mm03-D	.44	185-4-4X	.17	212-3/8A	.21	273A-4	.21	3120	.40	323-20X	.7
1107	.35	1308	.35	16mm11	.37	185-4mm	.17	212-4	.21	273A-6	.21	3120-D	.40	323-3X	.7
1107-D	.35	1308-D	.35	16mm13	.44	185-4X	.17	212-5	.21	273A-8	.21	3122	.40	323-4X	.7
1108	.35	1310	.35	16mm13-D	.44	185-5X	.17	212-5/16A	.21	273B-0	.21	3124	.40	323-5X	.7
1108-D	.35	1311	.35	16mm15	.54	185-5mm	.17	212-5/16A-ACR	.21	273B-1	.21	3124-D	.40	323-6X	.7
1109	.35	1311-D	.35	16mm15-D	.54	185-6X	.17	212-6	.21	273B-10	.21	3126	.40	324-0X	.7
1109-D	.35	1312	.35	16mm21	.37	185-6mm	.17	212-8	.21	273B-2	.21	315-10mm	.17	324-00X	.7
1110	.35	1313	.35	16mm23	.44	185-7X	.17	212-8A	.21	273B-3	.21	315-12mm	.17	324-000X	.7
1110-D	.35	1316	.35	16mm23-D	.44	185-7mm	.17	21mm03	.44	273B-4	.21	315-14mm	.17	324-1X	.7
1111	.35	1318	.35	16mm43	.44	185-8X	.17	21mm13	.44	273B-5	.21	315-2.5mm	.17	324-2X	.7
1111-D	.35	1320	.35	16mm43-D	.44	185-8mm	.17	21mm15	.54	273B-6	.21	315-3X	.17	324-20X	.7
1112	.35	13mm03	.44	170-0	.21	185-9mm	.17	21mm15-D	.54	273B-8	.21	315-4X	.17	324-3X	.7
1112-D	.35	13mm03-D	.44	170-1	.21	185-9X	.17	21mm23	.44	27mm15	.54	315-4mm	.17	324-4X	.7
1113	.35	13mm11	.37	170-1/2	.22	18mm03	.44	22mm03	.44	27mm15-D	.54	315-5X	.17	324-5X	.7
1114	.35	13mm11-D	.37	170-1/4	.22	18mm13	.44	22mm13	.44	28mm15	.54	315-5mm	.17	324-6X	.7
1114-D	.35	13mm13	.44	170-1/4-ACR	.22	18mm13-D	.44	22mm15	.54	28mm25	.54	315-6X	.17	325-0X	.7
1116	.35	13mm13-D	.44	170-1/4A	.22	18mm15	.54	22mm15-D	.54	28mm37	.64	315-6mm	.17	325-00X	.7
1116-D	.35	13mm15	.54	170-1/4B	.21	18mm15-D	.54	22mm23	.44	28mm38	.66	315-7X	.17	325-000X	.7
1118	.35	13mm15-D	.54	170-10	.21	18mm23	.44	23mm15	.54	3.5mm11	.37	315-7mm	.17	325-1X	.7
1120	.35	13mm21	.37	170-10-ACR	.21	18mm23-D	.44	23mm15-D	.54	3.5mmE1	.38	315-8X	.17	325-20X	.7
11mm03	.44	13mm21-D	.37	170-10A	.22	18mm43	.44	24 Bit Kit	.53	3010	.40	315-8mm	.17	325-3X	.7
11mm03-D	.44	13mm23	.44	170-2	.21	1950-0X	.20	24mm15	.54	3012	.40	320-0X	.7	325-4X	.7
11mm11	.37	13mm23-D	.44	170-3	.21	1950-1X	.20	24mm15-D	.54	3012-D	.40	320-00X	.7	325-5X	.7
11mm11-D	.37	13mm33	.44	170-3/8	.22	1950-2X	.20	25mm15	.54	3014	.40	320-000X	.7	325-6X	.7
11mm13	.44	13mm43	.44	170-3/8A	.22	1950-3X	.20	265-0	.21	3014-D	.40	320-1X	.7	326-0X	.7

Part Number Index

Part No.	Page	Part No.	Page	Part No.	Page	Part No.	Page	Part No.	Page	Part No.	Page	Part No.	Page
326-00X	7	3414-D	40	440-1-ACR1X	1	440-FX	15	446-12X	1	480-TX-45X	10	49-B-TX-15	11
326-000X	7	3416	40	440-1-ACR1-DX	1	440-TSQ-10M	24	446-1X	1	480-TX-50-H	10	49-B-TX-15-H	11
326-1X	7	3416-D	40	440-1-ACR1-RX	1	440-TSQ-4M	24	446-2-ACR2-DX	1	480-TX-50X	10	49-B-TX-15-W	11
326-2X	7	3418	40	440-1-PZDX	13	440-TSQ-5M	24	446-2-PZDX	13	480-TX-55-H	10	49-B-TX-20	11
326-20X	7	3418-D	40	440-1-SFX	14	440-TSQ-6M	24	446-2-SFX	14	480-TX-55X	10	49-B-TX-20-H	11
326-3X	7	3420	40	440-10IPX	12	440-TSQ-8M	24	446-215X	1	482X	2	49-B-TX-20-W	11
326-4X	7	3420-D	40	440-10IPRX	12	440-TX-05X	10	446-215T	1	483X	2	49-B-TX-25	11
326-5X	7	3424	40	440-115X	1	440-TX-06X	10	446-22X	1	484X	2	49-B-TX-27	11
326-6X	7	3424-D	40	440-12X	1	440-TX-07-H	10	446-225T	1	485-1X	7	49-B-TX-30	11
327-0X	7	3426	40	440-125X	1	440-TX-07X	10	446-22TX	1	485-2X	7	49-B-TX-30-W	11
327-00X	7	3428	40	440-13X	1	440-TX-08-H	10	446-23T	1	485-3X	7	49-B-TX-40	11
327-000X	7	3430	40	440-151PX	12	440-TX-08X	10	446-27X	1	485-4X	7	49-C-TX-07	11
327-1X	7	3430-D	40	440-151PRX	12	440-TX-09-H	10	446-2I	1	485-5X	7	49-C-TX-08	11
327-2X	7	3432	40	440-1X	1	440-TX-09X	10	446-2X	1	485-6X	10	49-C-TX-09	11
327-20X	7	3434	40	440-2-ACR2-DX	1	440-TX-10-H	10	446-FX	15	485-7X	7	49-C-TX-10	11
327-3X	7	3510	41	440-2-ACR2-RI	1	440-TX-10-W	10	451X	2	488	25	49-C-TX-15	11
327-4X	7	3511	41	440-2-ACR2-RX	1	440-TX-10X	10	452X	2	49-10IPX	12	49-C-TX-20	11
327-5X	7	3512	41	440-2-ACR2X	1	440-TX-15-125	10	453X	2	49-10IPRX	13	49-C-TX-20-H	11
327-6	10	3512-D	41	440-2-PZDX	13	440-TX-15-H	10	460	25	49-15IPX	12	49-C-TX-25	11
328-0X	7	3514	41	440-2-SFX	14	440-TX-15-W	10	48-TSQ-10M	24	49-15IPRX	13	49-C-TX-27	11
328-00X	7	3514-D	41	440-20IPX	12	440-TX-15X	10	48-TSQ-12M	24	49-20IPX	12	49-C-TX-30	11
328-000X	7	3516	41	440-20IPRX	12	440-TX-20-125	10	48-TSQ-14M	24	49-20IPRX	13	49-C-TX-40	11
328-1X	7	3516-D	41	440-215-PZDX	13	440-TSQ-20-2	10	48-TSQ-15M	24	49-25IPX	12	49-TSQ-10M	24
328-2X	7	3518	41	440-215-SFX	14	440-TX-20-H	10	48-TSQ-6M	24	49-25IPRX	13	49-TSQ-12M	24
328-20X	7	3518-D	41	440-215X	1	440-TX-20-W	10	48-TSQ-8M	24	49-27IPX	12	49-TSQ-4M	24
328-3X	7	3524	41	440-22-ACR2X	1	440-TX-20X	10	48-TX-45	11	49-27PRX	13	49-TSQ-5M	24
328-4X	7	3524-D	41	440-22-ACR2-DX	1	440-TX-25-H	10	48-TX-50	11	49-30IPX	12	49-TSQ-6M	24
328-5X	7	3530	41	440-22-ACR2-RX	1	440-TX-25-W	10	48-TX-55	11	49-30IPRX	13	49-TSQ-8M	24
328-6X	7	3532	41	440-22-PZDX	13	440-TX-25X	10	480	25	49-40IPX	12	49-TX-05	11
328-LX	9	3534	41	440-22-SFX	14	440-TX-27-H	10	480-1X	1	49-40IPRX	13	49-TX-06	11
328-MX	9	3607	42	440-225-SFX	14	440-TX-27-W	10	480-1-PZDX	13	49-A-10IPX	12	49-TX-07	11
328-PX	9	3608	42	440-225X	1	440-TX-27X	10	480-2-ACR2-RX	1	49-A-15IPX	12	49-TX-08	11
328-RX	9	3609	42	440-22X	1	440-TX-30-H	10	480-2-ACR2X	1	49-A-20IPX	12	49-TX-08-W	11
328-SX	9	3609-D	42	440-23X	1	440-TX-30-W	10	480-2-PZDX	13	49-A-25IPX	12	49-TX-09	11
3308	40	3610	42	440-24X	1	440-TX-30X	10	480-2-SF	14	49-A-27IPX	12	49-TX-10	11
3310	40	3610-D	42	440-255X	1	440-TX-40-H	10	480-22X	1	49-A-30IPX	12	49-TX-10-H	11
3310-D	40	3612	42	440-25IPX	12	440-TX-40-W	10	480-225X	1	49-A-TX-05	11	49-TX-10-W	11
3311	40	3612-D	42	440-25IPRX	12	440-TX-40I	10	480-24X	1	49-A-TX-06	11	49-TX-15	11
3312	40	3614	42	440-26X	1	440-TX-40X	10	480-2X	1	49-A-TX-07	11	49-TX-15-H	11
3312-D	40	3614-D	42	440-27X	1	440-TX-45X	10	480-3-ACR3X	1	49-A-TX-08	11	49-TX-15-W	11
3314	40	3616	42	440-27IPX	12	440-TX-50X	10	480-3-PZDX	13	49-A-TX-09	11	49-TX-20	11
3314-D	40	3616-D	42	440-27IPRX	12	445-0-15X	7	480-325X	1	49-A-TX-10	11	49-TX-20-5	11
3316	40	3618	42	440-2I	1	445-00X	7	480-34X	1	49-A-TX-10-H	11	49-TX-20-W	11
3316-D	40	3618-D	42	440-2X	1	445-00-15X	7	480-3X	1	49-A-TX-15	11	49-TX-25	11
3318	40	3620	42	440-3-ACR3X	1	445-000X	7	480-4-ACR4X	1	49-A-TX-15-H	11	49-TX-25-W	11
3318-D	40	3624	42	440-3-ACR3-DX	1	445-0X	7	480-425X	1	49-A-TX-15-W	11	49-TX-27	11
3320	40	3E10	42	440-3-ACR3-RX	1	445-1-15X	7	480-4BNX	1	49-A-TX-20	11	49-TX-27-W	11
3320-D	40	3E11	42	440-3-PZDX	13	445-10-15X	7	480-4X	1	49-A-TX-20-H	11	49-TX-30	11
3322	40	3E12	42	440-3-SFX	14	445-10X	7	480-FX	15	49-A-TX-25	11	49-TX-30-W	11
3322-D	40	3E14	42	440-30IPX	12	445-2-15X	7	480-TSQ-10M	24	49-A-TX-27	11	49-TX-40	11
3324	40	3E16	42	440-30IPRX	12	445-20X	7	480-TSQ-12M	24	49-A-TX-30	11	490	25
3324-D	40	3P10	42	440-3125X	1	445-20-15X	7	480-TSQ-14M	24	49-A-TX-40	11	490-10	25
3326	40	3P12	42	440-32X	1	445-2X	7	480-TSQ-6M	24	49-B-10IPX	12	490-3	25
3326-D	40	3P14	42	440-325X	1	445-3-15X	7	480-TSQ-8M	24	49-B-15IPX	12	490-4	25
3328	40	3P16	42	440-33X	1	445-30X	7	480-TX-20X	10	49-B-20IPX	12	490-5	25
3408	40	4.5mm11	37	440-34X	1	445-30-15X	7	480-TX-25X	10	49-B-25IPX	12	490-6	25
3408-D	40	400-BH	25	440-3BNX	1	445-3X	7	480-TX-27X	10	49-B-27IPX	12	490-8	25
3409	40	401X	3	440-3I	1	445-4-15X	7	480-TX-30X	10	49-B-30IPX	12	491-A-PZDX	13
3410	40	401-PZDX	13	440-3X	1	445-4X	7	480-TX-40-4X	10	49-B-TX-05	11	491-A-SFX	14
3410-D	40	402-PZDX	13	440-4-PZDX	13	445-5X	7	480-TX-40-H	10	49-B-TX-07	11	491-ACR1	5
3412	40	402X	3	440-40IPX	12	445-6	7	480-TX-40X	10	49-B-TX-08	11	491-ACR1-DX	5
3412-D	40	403X	3	440-40IPRX	12	446-0X	1	480-TX-45-6	10	49-B-TX-09	11	491-ACR1-RX	5
3414	40	403-PZDX	13	440-4X	1	446-1-PZDX	13	480-TX-45-H	10	49-B-TX-10	11	491-AFX	15

Part Number Index

Part No.	Page	Part No.	Page	Part No.	Page	Part No.	Page	Part No.	Page	Part No.	Page	Part No.	Page
4930-CCX	2	5210	49	5421	49	5616	52	6mm11	77	822	3	9mm11	37
494X	2	5212	49	5421-D	49	5616-D	52	6mm11-D	77	822-FX	15	9mm11-D	37
4mm11	37	5214	49	5422	49	5618	52	6mm13	91	825	26	9mm13	44
4mmE1	38	5216	49	5422-D	49	5618-D	52	6mm21	77	830	26	9mm13-D	44
5.5mm11	37	5216-D	49	5424	49	5620	52	6mm43	92	830-1X	2	9mm21	37
5.5mm21	37	5218	49	5424-D	49	5620-D	52	6mmE1	79	830-2X	2	9mm21-D	37
5.5mmE1	38	5218-D	49	5426	49	5622	52	6N-08-10M-3	28	830-3X	2	9mm23	44
50-TX-08	12	5220	49	5426-D	49	5624	52	6N-08-10M-4	28	830-4X	2	9mm23-D	44
50-TX-10	12	5222	49	5428	49	5624-D	52	6N-08-10M-6	28	832	3	9mm43	44
50-TX-15	12	5224	49	5430	49	5626	52	6N-08-12M-3	28	832-FX	15	9mm43-D	44
50-TX-20	12	5224-D	49	5430-D	49	5628	52	6N-08-12M-4	28	833	3	9mmE1	77
501X	3	5226	49	5432	49	5632	52	6N-08-12M-6	28	833-FX	15	A-1-10mm	85
501-AX	3	5226-D	49	5432-D	49	5634	52	6N-08-8M-3	28	834	3	A-1-11mm	85
502-AX	3	5228	49	5434	49	5636	52	6N-08-8M-4	28	834-FX	15	A-1-12mm	85
502-ACR2X	3	5228-D	49	5434-D	49	5636-D	52	6N-08-8M-6	28	834-TX-25	12	A-1-13mm	85
502-PZDX	13	5230	49	5436	49	5716	52	6N-0806-2	27	834-TX-45-5	12	A-1-6mm	85
502X	3	5230-D	49	5436-D	49	5720	52	6N-0806-3	27	834-TX-50	12	A-1-7mm	85
503X	3	5232	49	5438	49	5724	52	6N-0808-2	27	834-TX30-1.62	12	A-1-8mm	85
5108	49	5234	49	5440	49	5724-D	52	6N-0808-3	27	834-TX40-2.95	12	A-1-9mm	85
5110	49	5236	49	5440-D	49	5728	52	6N-0808-4	27	834-TX50-1.62	12	A-108	85
5110-D	49	5236-D	49	5442	49	5812	52	6N-0808-5	27	835	26	A-110	85
5112	49	5238	49	55-TX-10	12	5816-D	52	6N-0808-6	27	835	26	A-112	85
5112-D	49	5240	49	55-TX-15	12	5820	52	6N-0810-2	27	838	26	A-114	85
5114	49	5240-D	49	55-TX-20	12	5820-D	52	6N-0810-3	27	850	26	A-116	85
5114-D	49	5242	49	55-TX-25	12	5822	52	6N-0810-4	27	852	3	A-118	85
5116	49	5244	49	55-TX-30	12	5822-D	52	6N-0810-5	27	853	3	A-120	85
5116-D	49	5248	49	551X	3	5826-D	52	6N-0810-6	27	854	3	A-120	85
5118	49	5310	49	5510	50	5832-D	52	6N-0811-2	27	854-TX-50	12	A-3-10mm	85
5118-D	49												

Part Number Index

Part No.	Page	Part No.	Page	Part No.	Page	Part No.	Page	Part No.	Page	Part No.	Page	Part No.	Page
AN-09	18	CMS-3512	47	EX-370-10	29	EX-500-B-3	30	FL-1112	35	HC-100-1/2	82	KA-45-9	43
AN-10	18	CMS-3518	47	EX-370-2	29	EX-500-B-6	30	FL-1114	35	HC-100-1/4	82	KA-6-10m-4	46
AN-10-6	18	DB-08	27	EX-370-3	29	EX-500B-4	30	FL-1116	35	HC-100-10	82	KA-6-10m-6	46
AN-10mm	18	DB-10	27	EX-370-4	29	EX-501-10	30	FL-1212	35	HC-100-3/4	82	KA-6-10m-9	46
AN-12	18	DB-12	27	EX-370-5	29	EX-501-12	30	FL-1214	35	HC-100-3/8FS	82	KA-7-11m-12	46
AN-12-6	18	DMVCSFNC-623-13MM	29	EX-370-6	29	EX-501-15	30	FL-1216	35	HC-100-5/16	82	KA-7-12m-12	46
AN-12mm	18		80	EX-370-8	29	EX-501-2	30	FL-3012	41	HC-100-5/8	82	KA-7-12m-4	46
AN-14mm	18	EX-1005	67	EX-370-B	29	EX-501-3	30	FL-3014	41	HC-100-7/16	82	KA-7-12m-6	46
AN-14mm-6	18	EX-1005-B	67	EX-370-B-10	29	EX-501-4	30	FL-3016	41	HC-3520	40	KA-7-12m-9	46
AN-16	18	EX-250	29	EX-370-B-2	29	EX-501-5	30	FL-3018	41	HC-3816	40	KA-7-13m-12	46
AN-16-6	18	EX-250-12	29	EX-370-B-3	29	EX-501-6	30	FL-3022	41	HCNC-1130-D	73	KA-7-13m-3	46
AN-3mm	18	EX-250-2	29	EX-370-B-4	29	EX-501-8	30	FL-3024	41	HCNC-13014	77	KA-7-13m-4	46
AN-4mm	18	EX-250-3	29	EX-370-B-6	29	EX-501-B-10	30	FL-3110	41	HCNC-13414	77	KA-7-13m-6	46
AN-5mm	18	EX-250-4	29	EX-370-B-8	29	EX-501-B-12	30	FL-3112	41	HCNC-20918	77	KA-7-13m-9	46
AN-6mm	18	EX-250-5	29	EX-371	29	EX-501-B-2	30	FL-3114	41	HCNC-22512	77	KA-7-14m-6	46
AN-8mm	18	EX-250-6	29	EX-371-10	29	EX-501-B-3	30	FL-3116	41	HCNC-2424	77	KA-8-15m-12	46
AP-08	18	EX-250-8	29	EX-371-12	29	EX-501-B-4	30	FL-3118	41	HE-100-1/2	82	KA-8-15m-3	46
AP-10	18	EX-250-B	29	EX-371-15	29	EX-501-B-5	30	FL-3120	41	HE-100-1/4	82	KA-8-15m-9	46
AP-12	18	EX-250-B-12	29	EX-371-2	29	EX-501-B-6	30	FL-3122	41	HE-100-3/4	82	KAM-37-3	48
AP-16	18	EX-250-B-2	29	EX-371-2 3/4	29	EX-501-B-8	30	FL-3124	41	HE-100-3/8FS	82	KAM-38-6	48
AP-18	18	EX-250-B-3	29	EX-371-3	29	EX-502	30	FL-3210	42	HE-100-5/16	82	KB-10-19m-6	31
AP-20	18	EX-250-B-4	29	EX-371-4	29	EX-502-3	30	FL-3212	42	HE-100-5/8	82	KB-104-6	31
AP-24	18	EX-250-B-5	29	EX-371-5	29	EX-502-5	30	FL-3214	42	HE-100-7/16	82	KB-105-3	31
APH35M	19	EX-250-B-6	29	EX-371-6	29	EX-502-6	30	FL-3216	42	HE-1028	49	KB-202-12	31
APH38	19	EX-250-B-8	29	EX-371-8	29	EX-502-8	30	FL-3218	42	HE-1028-D	49	KB-202-6	31
APH56	19	EX-251	29	EX-371-B-3	29	EX-502-B	30	FL-3220	42	HE-530	49	KB-203-12	31
APH56M	19	EX-251-10	29	EX-372	39	EX-502-B-3	30	FL-3312	42	HFSF-14424	78	KB-203-9	31
AP3312LM	46	EX-251-2	29	EX-372-B	39	EX-502-B-4	30	FL-3314	42	HGSF-13824-A	78	KB-205-12	31
AP3312M	46	EX-251-3	29	EX-374	48	EX-503	48	FL-3316	42	HGSFNC-14524	78	KB-205-6	31
AP338	43	EX-251-6	29	EX-374-B	48	EX-503-B	48	FL-3318	42	HGSFNC-3028	78	KB-317-9	31
AP338L	43	EX-251-8	29	EX-376-10	48	EX-507-2	48	FL-3320	42	HT-848	83	KB-318-12	31
AP358XL	52	EX-251-B	29	EX-376-12	48	EX-507-3	48	FL-3324	42	HTN-B-1	24	KB-320-6	31
APU37	43	EX-251-B-2	29	EX-376-15	48	EX-507-4	48	FL-3326	42	HTN-B-2	24	KB-321-6	31
APU37M	46	EX-252	39	EX-376-18	48	EX-507-6	48	FL-3410	41	HTN-B-3	24	KB-322-3	31
APU56	52	EX-252-B	39	EX-376-2	48	EX-507-B-3	48	FL-3412	41	HTN-B-4	24	KB-322-6	31
AS-12	17	EX-254	48	EX-376-3	48	EX-507-B-4	48	FL-3414	41	HTS-0	24	KB-43-6	31
AW-95	28	EX-254-B	48	EX-376-4	48	EX-507-B-6	48	FL-5114	50	HTS-1	24	KB-45-3	31
AW-95-L	28	EX-255-10	39	EX-376-5	48	EX-512-2	30	FL-5116	50	HTS-10	24	KB-45-4	31
AW-95-LL	28	EX-255-12	39	EX-376-6	48	EX-512-3	30	FL-5118	50	HTS-12	24	KB-6-10m-6	31
BNAE-3mm	15	EX-255-14	39	EX-376-8	48	EX-512-B-2	30	FL-5120	50	HTS-2	24	KB-7-11m-6	31
BNAE-4mm	15	EX-255-2	39	EX-376-9	48	EX-512-B-4	30	FL-5122	50	HTS-3	24	KB-7-13m-12	31
BNAE-4mm-ACR	15	EX-255-3	39	EX-376-B-10	48	EX-620-3	30	FL-5124	50	HTS-3A	24	KB-7-13m-3	31
BNAE-5mm	15	EX-255-4	39	EX-376-B-12	48	EX-620-6	30	FL-5126	50	HTS-4	24	KB-7-13m-6	31
BNAE-5mm-ACR	15	EX-255-6	39	EX-376-B-15	48	EX-621-3	30	FL-5128	50	HTS-4A	24	KB-7-13m-9	31
BNAE-6mm	15	EX-255-8	39	EX-376-B-2	48	EX-621-6	30	FL-5130	50	HTS-5	24	KB-7-14m-6	31
BNAE-6mm-ACR	15	EX-255-B-2	39	EX-376-B-3	48	EX-621-8	30	FL-5132	50	HTS-6	24	KB-8-15m-12	31
BNAE-8mm	15	EX-255-B-4	39	EX-376-B-4	48	EX-621-B-3	30	FL-5134	50	HTS-7	24	KB-8-15m-6	31
BZCNC-30	77	EX-255-B-6	39	EX-376-B-5	48	EX-622	48	FL-5216	51	HTS-8	24	KB-8-15m-9	31
BZCNC-31	77	EX-257-2	48	EX-376-B-8	48	EX-750	48	FL-5218	51	HTS-9	24	KB-8-16m-6	31
CMS-1408	38	EX-257-3	48	EX-376-B-8	48	EX-750-B	48	FL-5222	51	KA-103-6	43	KB-8-16m-9	31
CMS-1409	38	EX-257-4	48	EX-376-B-9	48	EX-757-3	30	FL-5224	51	KA-104-9	43	KB-8-17m-12	31
CMS-1410	38	EX-257-5	48	EX-380	29	EX-757-B-3	30	FL-5226	51	KA-105-3	43	KB-8-18m-6	31
CMS-1412	38	EX-257-6	48	EX-380-2	29	EX-758-4	30	FL-5228	51	KA-105-4	43	KC-101-6	31
CMS-1414	38	EX-257-B-2	48	EX-380-3	29	EX-758-6	30	FL-5316	51	KA-105-6	43	KC-105-6	31
CMS-1507	38	EX-257-B-3	48	EX-380-4	29	EX-758-9	30	FL-5318	51	KA-105-9	43	KC-25-12	31
CMS-1508	38	EX-257-B-4	48	EX-380-6	29	EX-758-B-4	30	FL-5320	51	KA-205-3	43	KC-25-3	31
CMS-1509	38	EX-257-B-5	48	EX-380-B	29	EXL-1000	83	FL-5324	51	KA-43-6	43	KC-25-4	31
CMS-1510	38	EX-257-B-6	48	EX-380-B-2	29	EXL-1100	83	FL-5326	51	KA-44-3	43	KC-25-6	31
CMS-3412	47	EX-262	29	EX-500-2	30	EXL-15	79	FL-5416	50	KA-44-4	43	KC-25-9	31
CMS-3414	47	EX-262-4	29	EX-500-3	30	FL-HE9518	57	FL-5418	50	KA-44-6	43	KC-26-12	31
CMS-3416	47	EX-262-6	29	EX-500-4	30	FL-1108	35	FL-SH-335	50	KA-45-3	43	KC-26-3	31
CMS-3418	47	EX-262-B-4	29	EX-500-6	30	FL-1109	35	FL-SW-493	51	KA-45-4	43	KC-26-6	31
CMS-3420	47	EX-370	29	EX-500-B-2	30	FL-1110	35	HA-510	35	KA-45-6	43	KC-26-9	31



Part Number Index

Part No.	Page	Part No.	Page	Part No.	Page	Part No.	Page	Part No.	Page	Part No.	Page	Part No.	Page
KH-203-4	53	KS-7-11m-6	31	M-1114	35	M-3408	41	M-7mmE1	38	M6N-08-12M-6	27	MB-3210	41
KH-203-6	53	KS-7-13m-6	31	M-1116	35	M-3410	41	M-7mmE3	45	M6N-08-8M-3	27	MB-3212	41
KH-203-9	53	KS-7-13m-9	31	M-1118	35	M-3411	41	M-825	26	M6N-08-8M-4	27	MB-3214	41
KH-205-12	53	KSM-25-3	85	M-11mm03	44	M-3412	41	M-835	26	M6N-08-8M-6	27	MB-3216	41
KH-205-3	53	KSM-25-B-6	85	M-11mm11	74	M-3414	41	M-838	26	M6N-0806-2	27	MB-3218	41
KH-205-4	53	KSM-37-6	85	M-11mm13	44	M-3416	41	M-855	26	M6N-0806-3	27	MB-3220	41
KH-205-6	53	KSM-37-B-6	85	M-11mm21	37	M-3418	41	M-858	26	M6N-0806-5	27	MB-3314	41
KH-318-4	53	KT-10-19m-6	31	M-11mm43	44	M-3424	41	M-8mm11	37	M6N-0806-6	27	MB-3318	41
KH-320-6	53	KT-104-6	31	M-11mmE1	38	M-3426	41	M-8mm13	44	M6N-0808-2	27	MB-3512	41
KH-321-6	53	KT-105-12	31	M-11mmE3	45	M-3514	41	M-8mm21	37	M6N-0808-3	27	MB-3514	41
KH-322-6	53	KT-105-6	31	M-1208	35	M-44-90	25	M-8mm43	45	M6N-0808-4	27	MB-3516	41
KH-409-12	53	KT-105-9	31	M-1209	35	M-450	25	M-8mmE1	38	M6N-0808-5	27	MB-3520	41
KH-409-3	53	KT-202-12	31	M-1210	35	M-460	25	M-8mmE3	45	M6N-0808-6	27	MB-5212	50
KH-409-4	53	KT-202-6	31	M-1212	35	M-470	25	M-9mm11	37	M6N-0810-2	27	MB-5214	50
KH-409-6	53	KT-202-9	31	M-1214	35	M-480	25	M-9mm13	44	M6N-0810-3	27	MB-5216	50
KH-43-6	53	KT-203-12	31	M-12mm03	44	M-480-6	25	M-9mm21	37	M6N-0810-4	27	MB-5220	50
KH-44-6	53	KT-203-6	31	M-12mm11	37	M-488	25	M-9mmE1	38	M6N-0810-5	27	MB-5mm21	37
KH-45-3	53	KT-203-9	31	M-12mm13	44	M-490	25	M1E06	36	M6N-0810-6	27	MB-6mm21	37
KH-45-4	53	KT-205-12	31	M-12mm21	37	M-490-10	25	M1E07	36	M6N-0811-2	27	MB-6mm23	45
KH-45-6	53	KT-205-6	31	M-12mm43	45	M-490-12	25	M1E08	36	M6N-0811-3	27	MB-7mm21	37
KN-104-6	53	KT-317-9	31	M-12mmE1	38	M-490-2	25	M1E10	36	M6N-0812-2	27	MB-7mm23	45
KN-104-9	53	KT-318-6	31	M-13mm03	44	M-490-2-OR	25	M1E11	36	M6N-0812-3	27	MB-8mm21	37
KN-105-12	53	KT-320-12	31	M-13mm11	37	M-490-4	25	M1E12	36	M6N-0812-4	27	MB-8mm23	45
KN-105-6	53	KT-320-6	31	M-13mm13	44	M-490-6	25	M1E14	36	M6N-0812-6	27	MB-9mm21	37
KN-105-9	53	KT-320-9	31	M-13mm21	37	M-490-8	25	M1E16	36	M6N-0814-2	27	MB-9mm23	45

The Total Solution

The total solution from Cooper Power Tools includes not only a complete line of quality industrial tools and accessories but also a professional engineering and product support staff to help customize each tool to specific application requirements. All are as close as a telephone or e-mail.

Cooper Power Tools maintains company-owned Service Centers in strategic locations throughout the world, staffed with professional tool repair technicians who use genuine Cooper Power Tools parts and who are outfitted with the very latest in



testing, calibration and inspection equipment. Each tool that is returned to a customer from one of our Service Centers carries with it a warranty that is Cooper Power Tools' assurance that it will perform just like it did when it was purchased new.

Our support personnel are fully capable of helping to diagnose problems and promptly recommend solutions.

Our complete line of tools are carefully designed and

built from the finest materials available in order to provide years of trouble free service. But, as with any piece of equipment, service problems can occur. All tools are designed to be easy to service ... that is, of course, with properly trained personnel.

To facilitate quick repairs, and limit downtime ...

TRAINING

Cooper Power Tools conducts training seminars covering all aspects of every tool we make.

Introductory training seminars are designed to fully acquaint students with the entire line of tools and their fundamental operation. Advanced training seminars, which are often tailored to individual needs, are designed to hone the skills of the experienced student. Hands-on experience, with an emphasis on troubleshooting and repairing, are the focus of this training.

Service literature, product information, brand catalogs and FAQs are also available around the clock on the Web. Just access www.cooperpowertools.com for the latest information available about any of our products and services.

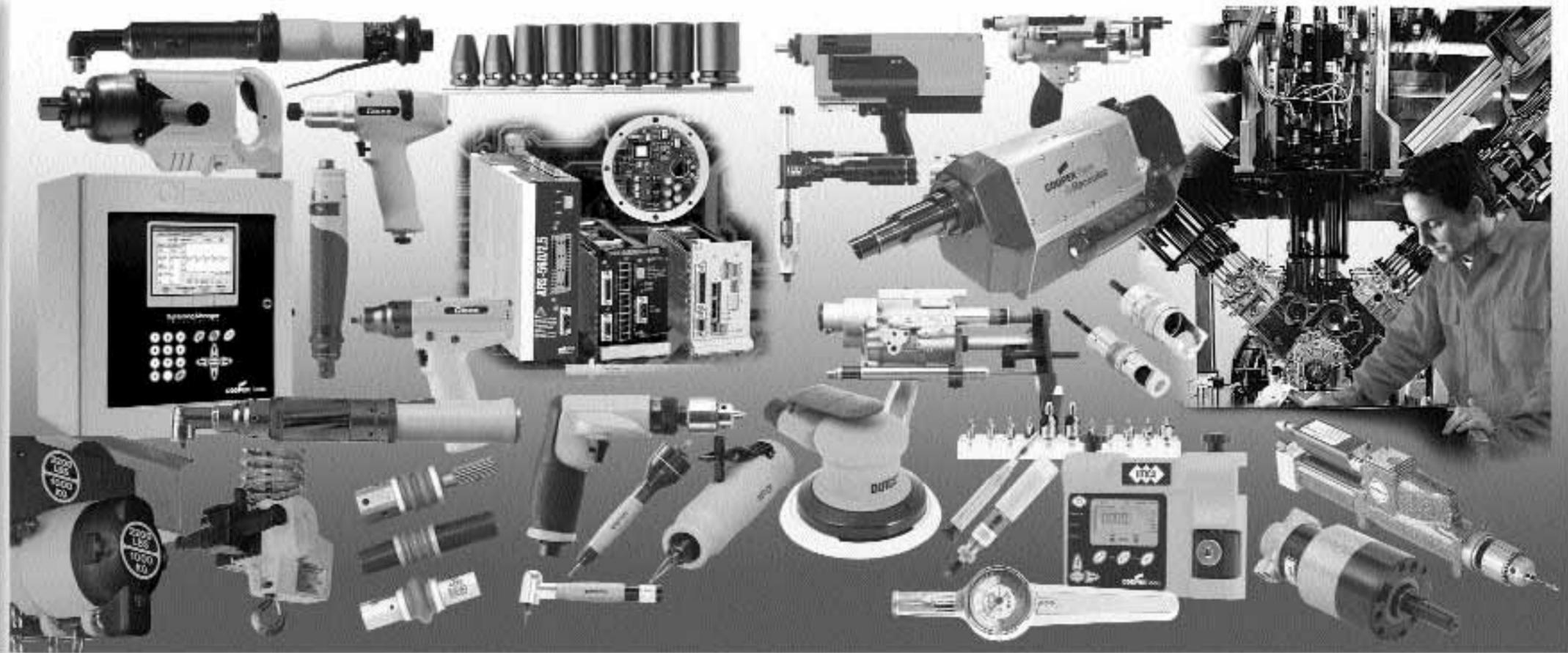
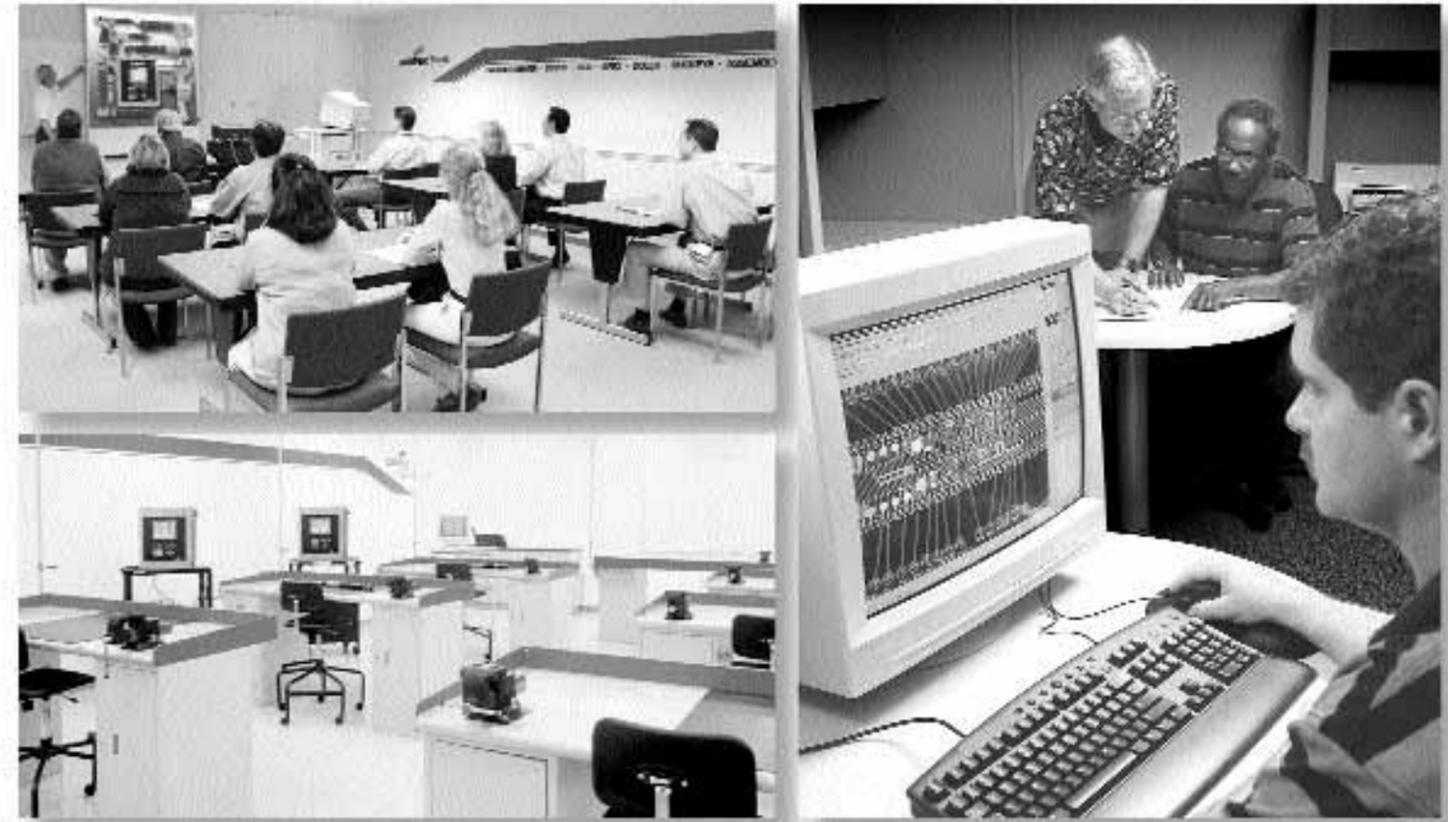

Note: All locations may not service all products. Please contact the nearest Sales & Service Center for the appropriate facility to handle your service requirements.

Dallas, TX
Cooper Power Tools Sales & Service Center
 1470 Post & Paddock
 Grand Prairie, TX 75050
 Tel: (972) 641-9563
 Fax: (972) 641-9674

Lexington, SC
Cooper Power Tools
 670 Industrial Drive
 Lexington, SC 29072
 Tel: (800) 845-5629
 Tel: (803) 359-1200
 Fax: (803) 359-0822

China
Cooper (China) Co., Ltd.
 18th Floor Yu An Building
 738 Dongfang Road
 Pudong, Shanghai 200122
 China
 Tel: 011 8621 5111 5300
 Fax: 011 8621 5111 8446

Detroit, MI
Cooper Power Tools Sales & Service Center
 4121 North Atlantic Blvd.
 Auburn Hills, MI 48326
 Tel: (248) 391-3700
 Fax: (248) 391-6295

Brazil
Cooper Power Tools Industrial Ltda.
 Av. Liberdade, 4055
 Zona Industrial - Iporanga
 18087-170 Sorocaba, SP Brazil
 Tel: (011) 55 15 238 3929
 Fax: (011) 55 15 228 3260

France
Cooper Power Tools SAS Recoules Operation
 Zone Industrielle
 BP 28
 Avenue Maurice Chevalier
 77831 Ozoir-la-Ferrière Cedex
 France
 Tel: (011) 33 1 64 43 22 00
 Fax: (011) 33 1 64 40 17 17

Houston, TX
Cooper Power Tools Sales & Service Center
 6550 West Sam Houston
 Parkway North, Suite 200
 Houston, TX 77041
 Tel: (713) 849-2364
 Fax: (713) 849-2047

Canada
Cooper Power Tools Sales & Service Center
 5925 McLaughlin Road
 Mississauga, Ont. L5R 1B8
 Canada
 Tel: (905) 501-4785
 Fax: (905) 501-4786

Germany
Cooper Power Tools GmbH & Co.
 Postfach 30
 D-73461 Westhausen
 Tel: +49 (0) 73 63-8 10
 Fax: +49 (0) 73 63-8 12 22

Mexico
Cooper Power Tools de México S.A. de C.V.
 Libramiento La Joya No. 1
 Bodega No. 2
 Esq. Politécnico, Barrio San José
 Cuautitlán, Edo de México C.P. 54870
 Phone: (011) 525 5899 9510
 Fax: (011) 525 5870 5012

Cooper Power Tools Is On The Web!

Cooper Power Tools provides a complete resource for power tools on-line. Our website www.cooperpowertools.com offers product information, service literature, brand catalogs, press releases and more. A dominant source of information, the Cooper Power Tools' website is your source for application solutions on-line.

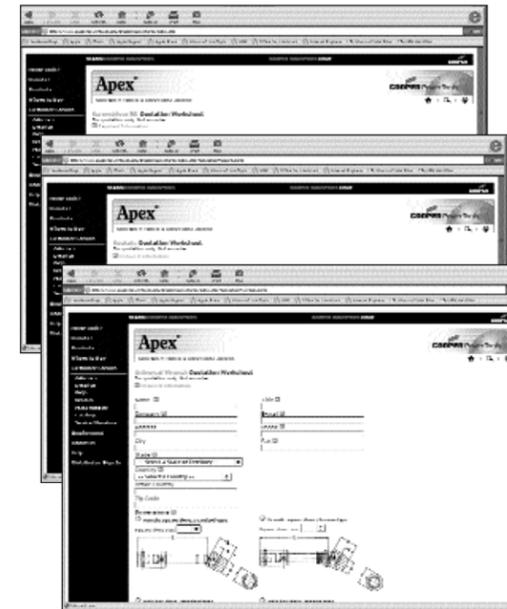

Making your job easier is our goal!

You can even specify custom tooling on-line fast! Specification sheets for bits, sockets, extensions and universal joints are available on-line. Just complete the appropriate form and submit your request. You'll receive a rapid response from one of our Apex Product Specialist.

Up-to-date product catalogs and service literature are also available online providing you with current information on our broad product line. Even Material Safety Data Sheets (M.S.D.S.) for Safety and Disposal Information are available on our website.



It's simple!

Our *Customer Service* section provides you with information such as answers to frequently asked questions or contact phone numbers and addresses for your area of the country. You can learn more about Cooper Power Tools in the *About Us* section or browse through the *What's New* information to learn



how Cooper Power Tools continues to be your source for solutions.

For even faster searches, you can go direct to a brand site by simply entering the brand name. Entering www.apex-tools.com takes you directly to the Apex brand site.



What is the future of www.cooperpowertools.com? A dynamic site continuing to focus on your need for up-to-date information on the latest Cooper Power Tools' offerings that you can access anytime you need...twenty-four hours a day, seven days a week!

Order Catalogs & Literature On-Line

One of the broadest range of tools in the world is at your fingertips!

Cooper Power Tools covers a wide range of industrial markets, including aerospace, automotive, foundries, furniture, general industry, metal fabrication, petroleum, power generation, shipbuilding, and transportation. These markets have been served by Cooper Power Tools' brands for many decades, by offering our customers solutions and products that meet their demanding productivity requirements.

To receive a product catalog quickly, just go to www.cooperpowertoolscatalogs.com. Select the literature or software you want. Then complete the "Contact Information" form, hit "Submit Request" and your order will be processed immediately. Materials normally arrive within 48 hours.

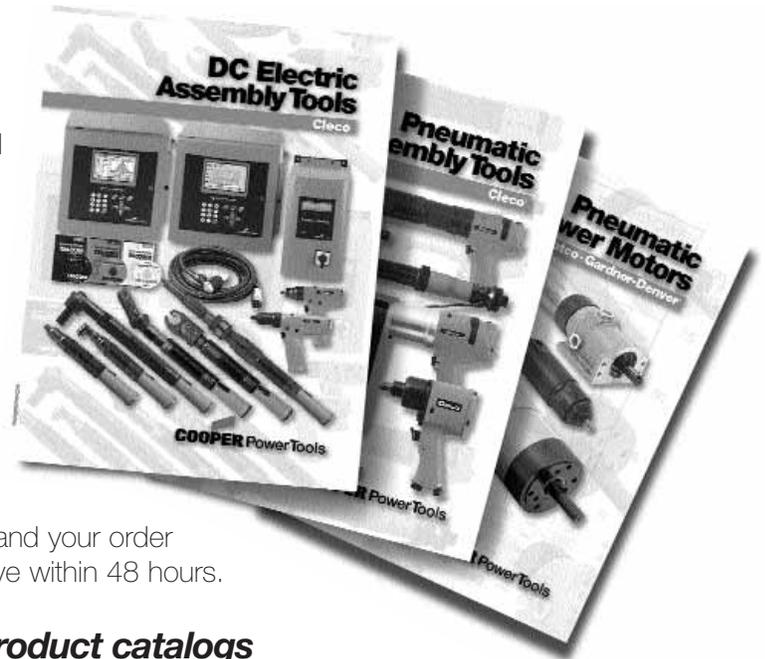

Below are a few of our more popular product catalogs

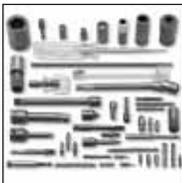

Apex Fastener Tools
A comprehensive line of industrial quality bits, finders, sockets and extensions.
(Catalog # TC-100)
www.apex-tools.com



Dotco/Cleco Material Removal Tools
A full line of pneumatic material removal tools including drills, sanders, and grinders.
(Catalog # SP-102)
www.dotco-tools.com

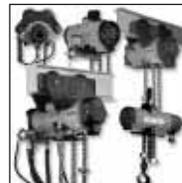

Gardner-Denver Air Hoists
A broad line of quality pneumatic hoists for industrial applications.
(Catalog # SP-103)
www.gardnerdenvertools.com



Apex Universal Joints
Industrial quality universal joints that can be custom designed for most any application.
(Catalog # SP-1400)
www.apexuniversal.com



Buckeye • Dotco • Gardner-Denver Power Motors
A comprehensive line of industrial pneumatic motors for a multitude of applications.
(Catalog # SP-104)
www.buckeye-tools.com



Master Power Industrial Air Tools
A complete line of industrial pneumatic tools for assembly and material removal applications.
(Catalog # SP-904)
www.masterpowertools.com



Cleco Pneumatic Assembly Tools
A full line of industrial pneumatic assembly tools from screwdrivers to nutrunners to impacts.
(Catalog # SP-1000)
www.clecotools.com



Buckeye Fixtured Drills
An extensive line of industrial pneumatic fixtured drills.
(Catalog # SP-105)
www.buckeye-tools.com



Utica Torque Products
A full line of torque measuring products including torque screwdrivers, torque wrenches and analyzers.
(Catalog # SP-301)
www.uticatools.com



Cleco D.C. Electric Assembly Tools
A complete line of industrial D.C. electric assembly tools and controllers.
(Catalog # SP-105)
www.clecotools.com

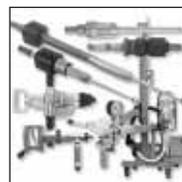

Airetool Tube Cleaners & Expanders
A complete line of industrial tube cleaners, expanders and installation tools.
(Catalog # SP-1100)
www.airetools.com



Cooper Power Tools
P.O. Box 1410
Lexington, SC 29071-1410
USA
Phone: 800-845-5629
Fax: 803-359-0822

Cooper Power Tools
5925 McLaughlin Road
Mississauga, Ontario
Canada L5R 1B8
Phone: (905) 501-4785
Fax: (905) 501-4786

**Cooper Power Tools
de México S.A. de C.V.**
Libramiento La Joya No. 1
Bodega No. 2
Esq. Politécnico
Barrio San José
Cuautitlán, Edo de México
C.P. 54870
Phone: (011) 525 5899 9510
Fax: (011) 525 5870 5012

Cooper Tools Industrial Ltda.
Av. Liberdade, 4055
Zona Industrial - Iporanga
18087-170 Sorocaba, SP
Brazil
Tel: +55-15-3238-3929
Fax: +55-15-228-3260

Cooper Power Tools SAS
Zone industrielle - B.P. 28
77831 Ozoir-la-Ferrière Cedex
France
Téléphone: +33-1-6443-2200
Téléfax: +33-1-6440-1717

**Cooper Power Tools
GmbH & Company**
Postfach 30
D-73461 Westhausen
Germany
Phone: +49-7363-810
Fax: +49-7363-81222

Cooper Tools Hungária Kft.
Berkenyefa sor 7
H-9027 Győr
Hungary
Tel: +36 96 505 300
Fax: +36 96 505 301

Cooper (China) Co., Ltd.
18th Floor Yu An Building
738 Dongfang Road
Pudong, Shanghai 200122
China
Phone: +86 21 5831 6805
Fax: +86 21 5831 6762

Visit us online at www.apex-tools.com

SEPTEMBER 2005

SPECIFICATIONS SUBJECT TO CHANGE WITHOUT NOTICE. © 2005 COOPER INDUSTRIES, INC. PRINTED IN USA. TC-100EN 0905 25M